

# R82 Toucan - E0638

## USD Retail Price List/ Order Form

Account #: \_\_\_\_\_ Purchase Order No.: \_\_\_\_\_ Date: \_\_\_\_\_

Contact: \_\_\_\_\_ Mark For: \_\_\_\_\_

Bill To:	Ship To:
Address:	Address:
City/State/Zip:	
Phone:	City/State/Zip:
Email	Phone:

### US Configuration

Effective: 01.01.22 Rev 5

- Toucan
- Footplate/Extra Foot Adj.
- Knee Support
- Hip/Side Support
- Back Support
- Chest Support
- Tray
- Head Support

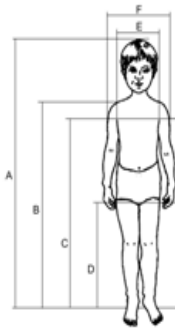

A (Total Height) \_\_\_\_\_  
 B (Shoulder Height) \_\_\_\_\_  
 C (Chest Height) \_\_\_\_\_  
 D (Buttock Height) \_\_\_\_\_  
 E (Chest Width) \_\_\_\_\_  
 F (Shoulder Width) \_\_\_\_\_  
 Age \_\_\_\_\_  
 Weight \_\_\_\_\_

### Measurements

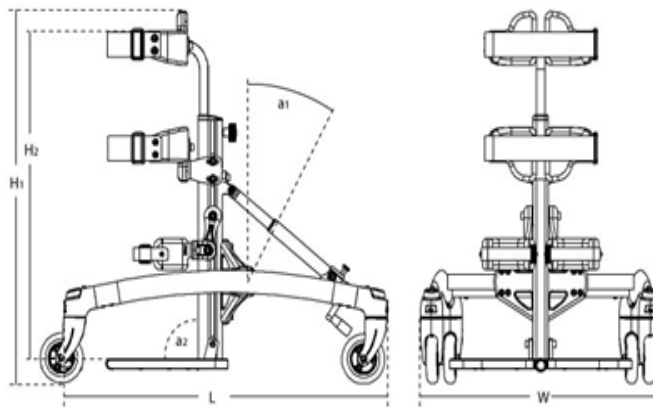

	Size 1 Inches	Size 2 Inches	Size 3 Inches	Size 4 Inches	Size 5 Inches
Width (G)	21¾"	24½"	24½"	27¼"	27¼"
Length (H)	29¼"	34¼"	34¼"	43¼"	43¼"
Total height (I1) *	26¼-34"	28-39½"	37¾-48"	40½-52¼"	48¼-60"
Height from foot/chest (I2)	13¼-27¼"	21-35"	29-43"	35½-47¼"	43¼-55"
Length, center bar	17½"	19½"	27½"	31¼"	39"
From floor to foot plate	2¼"	2¼"	2¼"	2½"	2½"
Angle of the center bar (a1)	0° to +30°	0° to +30°	0° to +30°	0° to +20°	0° to +20°
Angle of the foot plate (a2)	+15° to -10°	+15° to -10°	+15° to -10°	+15° to -10°	+15° to -10°
Weight	16½ lbs.	8½ lbs.	20 lbs.	10½ lbs.	24 lbs.
Max. user weight	67 lbs.	89 lbs.	111 lbs.	132 lbs.	154 lbs.
Approx. min. user height	24"	32"	42"	50½"	58½"
Approx. max. user height	38½"	42½"	56½"	62½"	71"

**Toucan Standard Features**

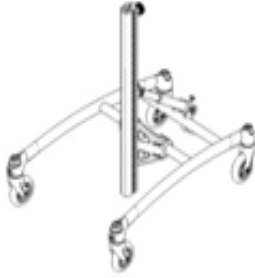

- Frame
- Castors
- Wheel Locks
- Center Bar
- Tilt Wind System

Description	Size	Part No.	USD Price	HCPCS
<input type="checkbox"/> Toucan Standing Frame, Red	1	861001	\$1,330	E0638
<input type="checkbox"/> Toucan Standing Frame, Blue	2	861002	\$1,330	E0638
<input type="checkbox"/> Toucan Standing Frame, Blue	3	861003	\$1,330	E0638
<input type="checkbox"/> Toucan Standing Frame, Silver	4	861004	\$1,481	E0638
<input type="checkbox"/> Toucan Standing Frame, Silver	5	861005	\$1,481	E0638

**Accessories**



Description	Measurements	Size	Part No.	USD Price	HCPCS
<input type="checkbox"/> Chest Support	11" x 15½" x 7½"	1	861704	\$214	
<input type="checkbox"/> Chest Support **	11" x 20-27" x 7½"	2, 3	861702	\$214	
<input type="checkbox"/> Chest Support **	16" x 25-32" x 10½"	4, 5	861703	\$235	

**\*\*Height and width adjustable**



<input type="checkbox"/> Chest Support (Pony Style) **	5½" x 8¾" x 4¾"	1	861801	\$307	
<input type="checkbox"/> Chest Support (Pony Style) **	5½" x 10¾" x 4¾"	2, 3	861802	\$307	
<input type="checkbox"/> Chest Support (Pony Style) **	5½" x 12¾" x 4¾"	4	861803	\$307	

**\*\*Thicker Pad**



<input type="checkbox"/> Chest Support (Mustang Style) **	15½"-25¼"	Small	861810	\$511	
<input type="checkbox"/> Chest Support (Mustang Style) **	26¼"-30¾"	Medium	861820	\$532	
<input type="checkbox"/> Chest Support (Mustang Style) **	34¼"-44¾"	Large	861830	\$564	

**\*\*Surrounding Pad Style**



<input type="checkbox"/> Extra Pad	H:4¾" x W:2¼"	One Size	869225	\$64	
------------------------------------	---------------	----------	--------	------	--

**For Mustang Style Chest Support**



<input type="checkbox"/> Cover for Chest Support		Small	869810-160	\$120	
<input type="checkbox"/> Cover for Chest Support		Medium	869820-260	\$147	
<input type="checkbox"/> Cover for Chest Support **		Large	869830-360	\$157	

**\*\*Custom order; Approx. lead time: 6-8 weeks (sz Large)**

**Description Measurements Size Part No. USD Price HCPCS**



<input type="checkbox"/> Filler Pad	4¼"	Small	861421	\$85	
-------------------------------------	-----	-------	--------	------	--

**Adds 1" expansion to chest or hip pads**





<input type="checkbox"/> Filler Pad	6¼"	Large	861422	\$85	
-------------------------------------	-----	-------	--------	------	--

**Adds 2" expansion to chest or hip pads**







<input type="checkbox"/> Tray with Storage Box		One Size	862501	\$412	
<input type="checkbox"/> Height Adjustment of Tray		One Size	862510	\$235	

Accessories	Description	Measurements	Size	Part No.	USD Price	HCPCS
	<input type="checkbox"/> Tray, Plastic, w/Bowl and Plate	24" x 22½"	1	861121	\$527	
	<input type="checkbox"/> Tray, Plastic, w/Bowl and Plate	24" x 22½"	2	861122	\$527	
	<input type="checkbox"/> Tray, Plastic, w/Bowl and Plate	24" x 22½"	3	861123	\$527	
	<input type="checkbox"/> Tray, Plastic, w/Bowl and Plate	24" x 22½"	4	861124	\$527	
	<input type="checkbox"/> Tray, Plastic, w/Bowl and Plate	24" x 22½"	5	861125	\$527	
	<input type="checkbox"/> Armrest for Plastic Tray w/ Bowl	9½" x 12½"	One Size	861131	\$167	
	<input type="checkbox"/> Toy Bar for Plastic Tray w/ Bowl		One Size	861135	\$250	
	<input type="checkbox"/> Grip Handle		One Size	8910750	\$422	
	<i>*Custom order; Approx. lead time: 6-8 weeks. Non-returnable item</i>					
	<input type="checkbox"/> Tray, Plastic, Grey		One Size	862515	\$402	

Description	Measurements	Size	Part No.	USD Price	HCPCS
-------------	--------------	------	----------	-----------	-------

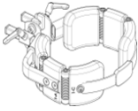
*All Hip Supports include a strap*

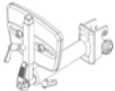
	<input type="checkbox"/> Hip Support w/ Pommel ♦	4¼" x 6" x 3"	1	861501	\$527	
	<input type="checkbox"/> Hip Support w/ Pommel •	4¼" x 8-10½" x 3"	2, 3	861502	\$527	
	<input type="checkbox"/> Hip Support w/ Pommel •	6¼" x 10-11½" x 4"	4	861503	\$584	
♦Height Adjustable •Height and Width Adjustable						
	<input type="checkbox"/> Hip Support, Front Mount ♦	4¼" x 6" x 3"	1	861601	\$245	
	<input type="checkbox"/> Hip Support, Front Mount •	4¼" x 8-10½" x 3"	2, 3	861602	\$245	
	<input type="checkbox"/> Hip Support, Front Mount •	6¼" 10-11½" x 4"	4	861603	\$277	
♦Height Adjustable •Height and Width Adjustable						
	<input type="checkbox"/> Hip Support w/Rotation ♦	4¼" x 6" x 3"	1	861611	\$370	
	<input type="checkbox"/> Hip Support w/Rotation •	4¼" x 8-10½" x 3"	2, 3	861612	\$370	
	<input type="checkbox"/> Hip Support w/Rotation •	6¼" x 10-11½" x 4"	4	861613	\$402	
♦Height Adjustable •Height and Width Adjustable						
	<input type="checkbox"/> Hip Support, Surrounding ••		1	861610	\$579	
	<input type="checkbox"/> Hip Support, Surrounding		2, 3	861620	\$579	
	<input type="checkbox"/> Hip Support, Surrounding ••		4	861630	\$589	
••Custom Order; Approx. lead time: 6-8 weeks.						
	<input type="checkbox"/> Extension for Center Bar (Ea.)	3¼"	One Size	861480	\$85	
	<input type="checkbox"/> Abdominal Support (Ea.)	5" x 7½"	One Size	861411	\$167	
	<input type="checkbox"/> Pommel and Sacral Support (Ea.)	5" x 7½"	One Size	861401	\$454	

Accessories	Description	Measurements	Size	Part No.	USD Price	HCPCS
-------------	-------------	--------------	------	----------	-----------	-------

**NOTE → The following items are required when ordering a Head Support:**

- Connecting System for Head Support
- Headrest of Choice
- Turtle Bar System
- Hip Support w/ Pommel



<input type="checkbox"/>	Connecting System for Head Support ♦		1, 2	861424-3	\$269	
<input type="checkbox"/>	Connecting System for Head Support ♦		3, 4	861424-4	\$269	

♦ **Required with Head Support**



**Swing-away Mounting Brackets - Height, Depth, Angle and Lateral Adjustable**

<input type="checkbox"/>	Turtle Bar System ♦	A: 5", B: 4-8½"	Short	98619-25	\$240	
<input type="checkbox"/>	Turtle Bar System ♦	A: 10", B: 4-8½"	Long	98619-26	\$240	

♦ **Required with Anatomic Head Support; 5099001, 5099002 or 5099003**

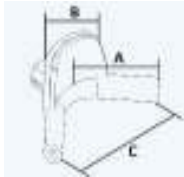

<input type="checkbox"/>	Anatomic Head Support ♦	A:5½ x B:5½ x C:9½"	Small	5099001	\$266	
<input type="checkbox"/>	Head Support Cover (Required)		Small	9923-83	N/C	
<input type="checkbox"/>	Anatomic Head Support ♦	A:6 x B:5½ x C:10"	Medium	5099002	\$266	
<input type="checkbox"/>	Head Support Cover (Required)		Medium	9945-83	N/C	
<input type="checkbox"/>	Anatomic Head Support ♦	A:6½ x B:5½ x C:12½"	Large	5099003	\$266	
<input type="checkbox"/>	Head Support Cover (Required)		Large	9967-83	N/C	

♦ **Turtle Bar System Short or Long Required; 98619-25 or 98619-26**

**Other types of headrest available, please see Head Supports Order Form**

Description	Measurements	Size	Part No.	USD Price	HCPCS
-------------	--------------	------	----------	-----------	-------



<input type="checkbox"/>	Knee Supports (Pr.) ♦	2½" x 2½"	1	861301	\$292	
<input type="checkbox"/>	Knee Supports (Pr.) ♦	2¾" x 3¼"	2, 3	861302	\$370	
<input type="checkbox"/>	Knee Supports (Pr.) ♦	2¾" x 4"	4, 5	861303	\$370	

♦ **Includes Straps**



<input type="checkbox"/>	Hinged Knee Supports (Pr.) ♦	3"	1	861311	\$454	
<input type="checkbox"/>	Hinged Knee Supports (Pr.) ♦	3¾"	2, 3	861312	\$454	
<input type="checkbox"/>	Hinged Knee Supports (Pr.) ♦	4½"	4, 5	861313	\$454	

♦ **Includes Straps**



<input type="checkbox"/>	Individual Footrest w/Hinged Sandals ♦		1	861201	\$412	
<input type="checkbox"/>	Individual Footrest w/Hinged Sandals ♦		2, 3	861202	\$412	

♦ **Includes Straps**

Accessories	Description	Measurements	Size	Part No.	USD Price	HCPCS
-------------	-------------	--------------	------	----------	-----------	-------



<input type="checkbox"/>	Flip-up Footplate ♦	12" x 12"	1	861211	\$230	
<input type="checkbox"/>	Flip-up Footplate ♦	17" x 14"	2, 3, 4, 5	861212	\$230	

♦ **Required with all Footplate Accessories**



<input type="checkbox"/>	Formed Footplates (Pr.) ♦	6¾"	0	86149	\$172	
<input type="checkbox"/>	Formed Footplates (Pr.) ♦	4" x 8½"	1, 2	86147	\$172	
<input type="checkbox"/>	Formed Footplates (Pr.) ♦	4½" x 9½"	3	86148	\$172	

♦ **Flip-Up Footplate Required; 861211 or 861212**



<input type="checkbox"/>	Foot Straps, Plastic Lock (Pr.)	Max: 22", A: 13½-20½"	One Size	85096	\$38	
<input type="checkbox"/>	Foot Straps, Velcro (Pr.)		One Size	85102	\$53	



<input type="checkbox"/>	Hinged Sandals w/Straps ♦	3¾" x 8"	1	861221	\$140	
<input type="checkbox"/>	Hinged Sandals w/Straps ♦	4½" x 9½"	2, 3	861222	\$140	
<input type="checkbox"/>	Hinged Sandals w/Straps ♦	6" x 12"	4, 5	861223	\$140	

♦ **Flip-Up Footplate Required; 861211 or 861212**



<input type="checkbox"/>	Heel Stop ♦	1½" x 4"	Small	861251	\$58	
<input type="checkbox"/>	Heel Stop ♦	4" x 5¾"	Large	861252	\$58	

♦ **Flip-Up Footplate Required; 861211 or 861212**

Spare Parts	Description	Measurements	Size	Part No.	USD Price
	<input type="checkbox"/> Strap for Hip Support		1	861621	\$64
	<input type="checkbox"/> Strap for Hip Support		2, 3	861622	\$64
	<input type="checkbox"/> Strap for Hip Support		4, 5	861623	\$64

Spare Parts	Description	Measurements	Size	Part No.	USD Price
	<input type="checkbox"/> Kit for Center Bar ●●		2	861902	\$167
	<input type="checkbox"/> Kit for Center Bar ●●		3	861903	\$182
	<input type="checkbox"/> Kit for Center Bar ●●		4	861904	\$204
	<input type="checkbox"/> Kit for Center Bar ●●		5	861905	\$235

●●Custom order; Approx. lead time: 6-8 weeks

	<input type="checkbox"/> Mounting for Back Support		One Size	861451	\$138
---	--	--	----------	--------	-------

	<input type="checkbox"/> Straps for Knee Supports (Pr.)		1	861341	\$58
	<input type="checkbox"/> Straps for Knee Supports (Pr.)		2, 3	861342	\$58

	<input type="checkbox"/> Straps for Flip-Up Footplate (Pr.)		1	861241	\$91
	<input type="checkbox"/> Straps for Flip-Up Footplate (Pr.)		2, 3	861242	\$91
	<input type="checkbox"/> Straps for Flip-Up Footplate (Pr.)		4, 5	861243	\$91

HCPCS codes are provided for your convenience and are NOT to be considered billing or legal advice. Providers are responsible for insuring that all appropriate billing codes are used when submitting claims. Proper use of HCPCS codes does not insure coverage or payment. Contact the appropriate payer for coverage information.

Prices in USD & is subject to change without notice

For Quotes and Orders please send completed Order Form to: [sales.us@etac.com](mailto:sales.us@etac.com) or Fax: 1-800-760-0537

OF6400-ENG-REV.05

Etac  
13137 Bleinheim Lane  
Matthews, North Carolina 28105  
+1 844-US-MOBILITY (844-876-6245)  
[www.etac.us.com](http://www.etac.us.com)

  
Creating Possibilities