

# R82 Caribou - E0641

## USD Retail Price List/ Order Form



Account #: \_\_\_\_\_ Purchase Order No.: \_\_\_\_\_ Date: \_\_\_\_\_  
 Contact: \_\_\_\_\_ Mark For: \_\_\_\_\_

|                 |                 |
|-----------------|-----------------|
| Bill To:        | Ship To:        |
| Address:        | Address:        |
| City/State/Zip: | City/State/Zip: |
| Phone:          | City/State/Zip: |
| Email           | Phone:          |

### US Configuration

Effective: 06/16/2018 - Rev 5

- Caribou
- Top Pad/Shoulder Support
- Cross Straps/Back Support
- Chest Strap
- Head Support
- Extra Cushion
- Hip/Side Support
- Knee Support/Pommel with Strap
- Tray

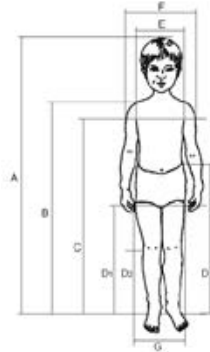

- A (Total Height) \_\_\_\_\_
- B (Shoulder Height) \_\_\_\_\_
- C (Chest Height) \_\_\_\_\_
- D (Top of Pelvis) \_\_\_\_\_
- D1 (Buttock Height) \_\_\_\_\_
- D2 (Below Knee) \_\_\_\_\_
- E (Chest Width) \_\_\_\_\_
- F (Shoulder Width) \_\_\_\_\_
- G (Pelvis Width) \_\_\_\_\_
- Age \_\_\_\_\_
- Weight \_\_\_\_\_

### Measurements

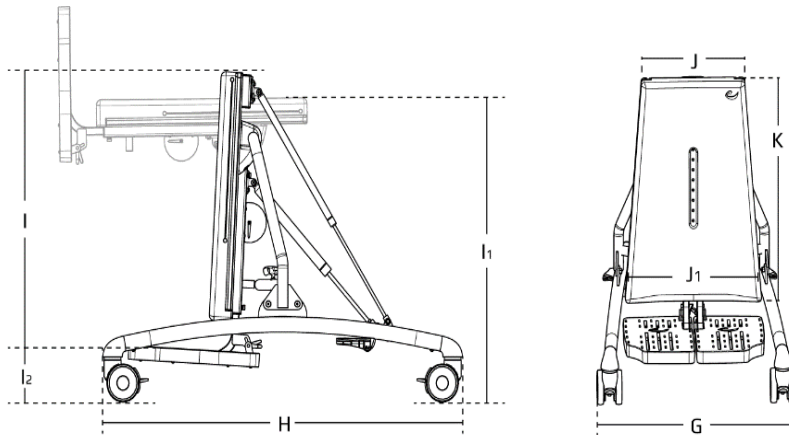

|                                      | Size 1<br>Inches | Size 2<br>Inches | Size 3<br>Inches | Size 4<br>Inches |
|--------------------------------------|------------------|------------------|------------------|------------------|
| Frame width (G)                      | 20"              | 22½"             | 25½"             | 29¼"             |
| Frame length (H)                     | 29¼"             | 36"              | 43¼"             | 43¼"             |
| Height, vertical (I)                 | 18-22½"          | 20¾-25¼"         | 26¾-31"          | 34¾-39"          |
| Height, horizontal (I1)              | 27½"             | 27½"             | 31½"             | 31½"             |
| Height from floor to frame (I2)      | 5"               | 5"               | 5"               | 5"               |
| Basis plate width, top-bottom (J-J1) | 9¾-12½"          | 11¾-15"          | 13¾-18"          | 15¾-21¾"         |
| Basis plate height (K)               | 17"              | 19¾"             | 25½"             | 33½"             |
| Angling                              | 0-87°            | 0-87°            | 0-87°            | 0-87°            |
| Foot plate angling                   | -10-10°          | -10-10°          | -10-10°          | -10-10°          |
| Weight, wo/power                     | 45.2 lbs.        | 53 lbs.          | 67.2 lbs.        | 77.2 lbs.        |
| Weight, w/power                      | 49.6 lbs.        | 56.2 lbs.        | 71.7 lbs.        | 81.6 lbs.        |
| Max load                             | 88.2 lbs.        | 132.3 lbs.       | 176.4 lbs.       | 220½"            |
| Approximate total user height        | 22-42"           | 32-52"           | 42-60"           | 52-72"           |

## Caribou Standard Features



- Sizes 1, 2, 3 and 4
- 4" Locking Castors
- Contoured Top Plate
- Tilt: From Vertical to Horizontal
- Height and Angle Adjustable 2-Piece Footrest

| Description | Size | Part No. | USD Price |
|-------------|------|----------|-----------|
|-------------|------|----------|-----------|

**Important: For sizes 3 and 4 it is recommended to use the power version to ease the tilting; see below**

|   |   |           |         |
|---|---|-----------|---------|
| <input type="checkbox"/> Caribou Base w/ 2-Piece Footrest | 1 | 860101-FP | \$2,730 |
| <input type="checkbox"/> Caribou Base w/ 2-Piece Footrest | 2 | 860102-FP | \$2,830 |
| <input type="checkbox"/> Caribou Base w/ 2-Piece Footrest | 3 | 860113-FP | \$3,135 |
| <input type="checkbox"/> Caribou Base w/ 2-Piece Footrest | 4 | 860114-FP | \$3,645 |

| Description | Size | Part No. | USD Price |
|-------------|------|----------|-----------|
|-------------|------|----------|-----------|

|  |   |             |         |
|--|---|-------------|---------|
| <input type="checkbox"/> Caribou Base with Power Actuator ●● | 1 | 860101-ELFP | \$4,260 |
| <input type="checkbox"/> Caribou Base with Power Actuator ●● | 2 | 860102-ELFP | \$4,360 |
| <input type="checkbox"/> Caribou Base with Power Actuator    | 3 | 860103-ELFP | \$4,665 |
| <input type="checkbox"/> Caribou Base with Power Actuator    | 4 | 860104-ELFP | \$5,175 |

●●Custom order; Approx. lead time: 6-8 weeks. Non-returnable item (Sz 1 and 2)

| Description | Measurements | Size | Part No. | USD Price |
|-------------|--------------|------|----------|-----------|
|-------------|--------------|------|----------|-----------|

**Required, must select one:**

|                                    |                       |   |          |     |
|------------------------------------|-----------------------|---|----------|-----|
| <input type="checkbox"/> Top Pad ♦ | W1:6, W2:7, H:7¾"     | 1 | 861101-1 | N/C |
| <input type="checkbox"/> Top Pad ♦ | W1:7½, W2:9, H:9¾"    | 2 | 861101-2 | N/C |
| <input type="checkbox"/> Top Pad ♦ | W1:8¾, W2:10½, H:12½" | 3 | 861101-3 | N/C |
| <input type="checkbox"/> Top Pad ♦ | W1:9¾, W2:12¼, H:15¾" | 4 | 861101-4 | N/C |

♦ Top Pad size must match Shoulder Support size

|                                   |               |      |          |       |
|-----------------------------------|---------------|------|----------|-------|
| <input type="checkbox"/> Head Pad | W: 6", H: 7½" | 1, 2 | 861116-1 | \$505 |
| <input type="checkbox"/> Head Pad | W: 8", H: 9½" | 3, 4 | 861116-2 | \$505 |

| Description | Measurements | Size | Part No. | USD Price |
|-------------|--------------|------|----------|-----------|
|-------------|--------------|------|----------|-----------|

|  |              |          |          |       |
|--|--------------|----------|----------|-------|
| <input type="checkbox"/> Extra Cushion (Ea.) | W:9¾" x H:3" | One Size | 861106-1 | \$230 |
| <input type="checkbox"/> Extra Cushion (Ea.) | W:11¾ x H:4" | One Size | 861106-2 | \$230 |
| <input type="checkbox"/> Extra Cushion (Ea.) | W:13¾ x H:4" | One Size | 861106-3 | \$250 |
| <input type="checkbox"/> Extra Cushion (Ea.) | W:15¾ x H:4" | One Size | 861106-4 | \$250 |

| Accessories | Description | Measurements | Size | Part No. | USD Price |
|-------------|-------------|--------------|------|----------|-----------|
|-------------|-------------|--------------|------|----------|-----------|

■ XX = 60 (Black)

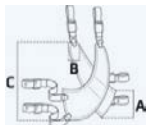



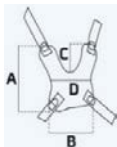





|   |                       |   |           |       |
|---|-----------------------|---|-----------|-------|
| <input type="checkbox"/> Cross Vest (Ea.) | A: 5 x B:½ x C:12"    | 1 | 89625-1XX | \$190 |
| <input type="checkbox"/> Cross Vest (Ea.) | A: 5½ x B:½ x C:13"   | 2 | 89625-2XX | \$190 |
| <input type="checkbox"/> Cross Vest (Ea.) | A: 6¼ x B:2½ x C:15¼" | 3 | 89625-3XX | \$190 |



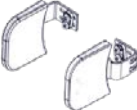

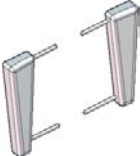

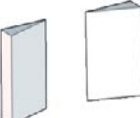



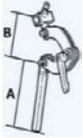
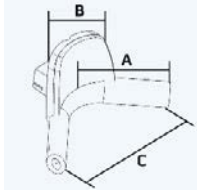

|  |                             |   |         |       |
|--|-----------------------------|---|---------|-------|
| <input type="checkbox"/> Neoprene Vest (Ea.) | A:7 x B:5½ x C:4 x D:4½"    | 1 | 89113-1 | \$200 |
| <input type="checkbox"/> Neoprene Vest (Ea.) | A:10½ x B:11 x C:6½ x D:5¾" | 2 | 89113-2 | \$200 |
| <input type="checkbox"/> Neoprene Vest (Ea.) | A:11¼ x B:9 x C:7 x D:6½"   | 3 | 89113-3 | \$200 |



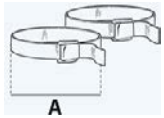

|  |  |   |         |       |
|--|--|---|---------|-------|
| <input type="checkbox"/> Chest Belt, Upholstered (Ea.) |  | 1 | 85428-1 | \$270 |
| <input type="checkbox"/> Chest Belt, Upholstered (Ea.) |  | 2 | 85428-2 | \$270 |
| <input type="checkbox"/> Chest Belt, Upholstered (Ea.) |  | 3 | 85428-3 | \$270 |

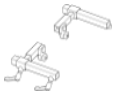
| Accessories  | Description   | Measurements              | Size                      | Part No.  | USD Price |
|--|---|---------------------------|---------------------------|-----------|-----------|
|               | <input type="checkbox"/> Fix-Locks, Black, Bag of 6 Pcs ♦<br>♦ <i>Required for use of Vests</i> |                           | One Size                  | 862109-35 | \$42      |
| <b>Other types of vests and belts available, please see Vest and Belts Order Form</b>          |   |                           |                           |           |           |
|               | <input type="checkbox"/> Chest Strap (Ea.)  | W: 16½-24¾"               | 1, 2                      | 862101-2  | \$120     |
|  | <input type="checkbox"/> Chest Strap (Ea.)  | W: 19-30¼"                | 3                         | 862101-3  | \$120     |
|  | <input type="checkbox"/> Chest Strap (Ea.)  | W: 22¾-37¾"               | 4                         | 862101-4  | \$120     |
| <i>Note: A chest strap is not included as standard, quantity of two straps is recommended.</i> |   |                           |                           |           |           |
|               | <input type="checkbox"/> Cross Straps (Pr.)   | 15-19¼"                   | 1                         | 862102-1  | \$280     |
|  | <input type="checkbox"/> Cross Straps (Pr.)   | 17-21½"                   | 2                         | 862102-2  | \$280     |
|  | <input type="checkbox"/> Cross Straps (Pr.)   | 20¾-27½"                  | 3                         | 862102-3  | \$295     |
|  | <input type="checkbox"/> Cross Straps (Pr.) ♦♦  | 24¾-33¾"                  | 4                         | 862102-4  | \$295     |
| <i>♦♦Custom order; Approx. lead time: 6-8 weeks (Size 4)</i>                                   |   |                           |                           |           |           |
|               | <input type="checkbox"/> Side Supports, Fixed, Type 7 (Pr.) Pad: 44.33 x 4.72"                  |                           | 1, 2                      | 861102-10 | \$250     |
|  | <input type="checkbox"/> Side Supports, Fixed, Type 5 (Pr.) Pad: 6.3 x 5.9"                     |                           | 3, 4                      | 861102-20 | \$300     |
|               | <input type="checkbox"/> Side Supports, size 1 (Pr.)  | L: 5½ X H:5½ x W:3¾"      | One Size                  | 861102-1  | \$285     |
|  | <input type="checkbox"/> Side Supports, size 2 (Pr.)  | L: 6½ X H:7 x W:5"        | One Size                  | 861102-2  | \$285     |
|  | <input type="checkbox"/> Side Supports, size 3 (Pr.)  | L: 7¾ H:7 x W:5"          | One Size                  | 861102-3  | \$285     |
| <i>Width between laterals on torso pad (min-max)</i>   |   |                           |                           |           |           |
|  | <b>Size 1: 4" to 9"</b>   | <b>Size 2: 6½" to 14"</b> | <b>Size 3: 12" to 18"</b> |           |           |
|             | <input type="checkbox"/> Lateral Support Strap (Ea.)  | 10-12½"                   | 1                         | 862103-1  | \$51      |
|  | <input type="checkbox"/> Lateral Support Strap (Ea.)  | 13-16"                    | 2                         | 862103-2  | \$51      |
|  | <input type="checkbox"/> Lateral Support Strap (Ea.)  | 13½-19¾"                  | 3                         | 862103-3  | \$51      |
|             | <input type="checkbox"/> Shoulder Support (Pr.) ♦   | W:3, H:7½, D:2"           | 1                         | 861126-1  | \$255     |
|  | <input type="checkbox"/> Shoulder Support (Pr.) ♦   | W:3¼ H:9¾, D:2"           | 2                         | 861126-2  | \$255     |
|  | <input type="checkbox"/> Shoulder Support (Pr.) ♦   | W:4, H:12½, D:2"          | 3                         | 861126-3  | \$255     |
|  | <input type="checkbox"/> Shoulder Support (Pr.) ♦   | W:4¼H:15¼ D:2"            | 4                         | 861126-4  | \$255     |
| <i>♦ Shoulder Support size must match Top Pad size.</i>  |   |                           |                           |           |           |
|             | <input type="checkbox"/> Upper Arm Support, Small   |                           | 1, 2                      | 861109-10 | \$375     |
|  | <input type="checkbox"/> Upper Arm Support, Large   |                           | 3, 4                      | 861109-20 | \$400     |
|             | <input type="checkbox"/> Wedges for Side Slots (Pr.) ♦♦   |                           | 1                         | 861107-1  | \$16      |
|  | <input type="checkbox"/> Wedges for Side Slots (Pr.) ♦♦   |                           | 2                         | 861107-2  | \$16      |
|  | <input type="checkbox"/> Wedges for Side Slots (Pr.) ♦♦   |                           | 3                         | 861107-3  | \$16      |
| <i>♦♦Custom order; Approx. lead time: 6-8 weeks (All Sizes)</i>                                |   |                           |                           |           |           |
|             | <input type="checkbox"/> Back Support (Ea.) ♦♦  |                           | 1, 2                      | 861115-2  | \$295     |
|  | <input type="checkbox"/> Back Support (Ea.)   |                           | 3, 4                      | 861115-3  | \$300     |
| <i>♦♦Custom order; Approx. lead time: 6-8 weeks (Sizes 1 &amp; 2)</i>                          |   |                           |                           |           |           |

| Accessories   | Description  | Measurements          | Size     | Part No.  | USD Price |
|---|--|-----------------------|----------|-----------|-----------|
|    | <input type="checkbox"/> Turtle Bar System ♦<br>♦ <b>Required with all Head Supports</b> | A: 10", B: 4-8½"      | Long     | 98619-26  | \$230     |
|    | <input type="checkbox"/> Anatomic Head Support ♦   | A:5½ x B:5½ x C:9½"   | Small    | 5099001   | \$255     |
|   | <input type="checkbox"/> Head Support Cover ( <b>Required</b> )                          |                       | Small    | 9923-83   | N/C       |
|   | <input type="checkbox"/> Anatomic Head Support ♦   | A:6 x B:5½ x C:10"    | Medium   | 5099002   | \$255     |
|   | <input type="checkbox"/> Head Support Cover ( <b>Required</b> )                          |                       | Medium   | 9945-83   | N/C       |
|   | <input type="checkbox"/> Anatomic Head Support ♦   | A:6½ x B:5½ x C:12½"  | Large    | 5099003   | \$255     |
|   | <input type="checkbox"/> Head Support Cover ( <b>Required</b> )                          |                       | Large    | 9967-83   | N/C       |
|   | ♦ <b>Turtle Bar System Short or Long Required; 98619-25 or 98619-26</b>                  |                       |          |           |           |
| <b>Other types of headrest available, please see Head Supports Order Form</b>       |  |                       |          |           |           |
| <hr/>   |  |                       |          |           |           |
| Description   | Measurements   | Size                  | Part No. | USD Price |           |
|    | <input type="checkbox"/> Pommel, Size 1 (Ea.)  | W1:2,W2:2¾,H:6,D:3½"  | One Size | 861103-1  | \$135     |
|   | <input type="checkbox"/> Pommel, Size 2 (Ea.)  | W1:6,W2:2¾,H:6,D:6¾"  | One Size | 861103-2  | \$135     |
|    | <input type="checkbox"/> Strap for Pommel, Sz 1 (Ea.) ●●                                 | L:9.84 - 11.81"       | One Size | 862104-1  | \$145     |
|   | <input type="checkbox"/> Strap for Pommel, Sz 2 (Ea.) ●●                                 | L:10.63 - 18½"        | One Size | 862104-2  | \$145     |
|   | ●● <b>Custom order; Approx. lead time: 6-8 weeks</b>                                     |                       |          |           |           |
|   | <input type="checkbox"/> Knee Support, Fixed, sz 1                                       |                       | 1, 2     | 861144-2  | \$385     |
|   | <input type="checkbox"/> Knee Support, Hinged, Fixed, sz 1 ●●                            |                       | 1, 2     | 861144-20 | \$535     |
|   | <input type="checkbox"/> Knee Support, Fixed, sz 2 **                                    |                       | 3, 4     | 861144-3  | \$385     |
|   | <input type="checkbox"/> Knee Support, Hinged, Fixed, sz 2 ●●                            |                       | 3, 4     | 861144-30 | \$535     |
|   | ●● <b>Custom order; Approx. lead time: 6-8 weeks</b>                                     |                       |          |           |           |
|   | <input type="checkbox"/> Knee Support, Swing-Away, sz 1                                  |                       | 1, 2     | 861154-2  | \$665     |
|   | <input type="checkbox"/> Knee Support, Hinged, Swing-Away, sz 1                          |                       | 1, 2     | 861154-20 | \$815     |
|   | <input type="checkbox"/> Knee Support, Swing-Away, sz 2                                  |                       | 3, 4     | 861154-3  | \$665     |
|   | <input type="checkbox"/> Knee Support, Hinged, Swing-Away, sz 2                          |                       | 3, 4     | 861154-30 | \$815     |
|  | <input type="checkbox"/> Formed Footplates (Pr.)   | L: 8½"                | 1, 2     | 86147     | \$165     |
|   | <input type="checkbox"/> Formed Footplates (Pr.)   | L: 9¼"                | 3, 4     | 86148     | \$165     |
|  | <input type="checkbox"/> Foot Straps, Plastic Lock (Pr.)                                 | Max: 22", A: 13½-20½" | One Size | 85096     | \$36      |
|   | <input type="checkbox"/> Foot Straps, Velcro (Pr.)                                       |                       | One Size | 85102     | \$51      |
|  | <input type="checkbox"/> Heel Support for Parted Foot Support (Pr.)                      |                       | 1, 2     | 861251    | \$56      |
|   | <input type="checkbox"/> Heel Support for Parted Foot Support (Pr.)                      |                       | 3, 4     | 861252    | \$56      |
|  | <input type="checkbox"/> Upholstered Ankle Straps (Pr.)                                  |                       | 1        | 85426-1   | \$185     |
|   | <input type="checkbox"/> Upholstered Ankle Straps (Pr.)                                  |                       | 2        | 85426-2   | \$185     |
|   | <input type="checkbox"/> Upholstered Ankle Straps (Pr.)                                  |                       | 3        | 85426-3   | \$185     |

| Accessories   | Description   | Measurements | Size     | Part No.   | USD Price |
|---|---|--------------|----------|------------|-----------|
| <b>Both Trays can be used in Prone and Supine Position</b>                        |   |              |          |            |           |
|  | <input type="checkbox"/> Tray, Plastic, with Bowl & Cover (Ea.) |              | 1, 2     | 862130-2   | \$560     |
|   | <input type="checkbox"/> Tray, Plastic, with Bowl & Cover (Ea.) |              | 3, 4     | 862130-3   | \$560     |
| <b>For Supine Use Only</b>  |   |              |          |            |           |
|  | <input type="checkbox"/> Low Mount Kit for Plastic Tray ♦       |              | One Size | 862131-KIT | \$205     |
|   | ♦ <b>Plastic Tray required (862130-2 or 862130-3)</b>           |              |          |            |           |
|  | <input type="checkbox"/> Armrest for Plastic Tray               |              | One Size | 861131     | \$160     |
|   | <input type="checkbox"/> Toybar for Plastic Tray                |              | One Size | 861135     | \$240     |
|  | <input type="checkbox"/> Grip Handle for Tray ♦♦                |              | One Size | 8910750    | \$405     |
|   | ♦♦ <b>Custom order; Approx. lead time: 6-8 weeks</b>            |              |          |            |           |
|  | <input type="checkbox"/> Helper's Handle ♦                      |              | One Size | 861108-U   | \$140     |
| ♦ <b>For moving and tilting the Caribou</b>                                       |   |              |          |            |           |

| Spare Parts   | Description   | Measurements | Size     | Part No. | USD Price |
|---|---|--------------|----------|----------|-----------|
|  | <input type="checkbox"/> Power Kit, Complete (Ea.)                |              | 1, 2     | 861140   | \$2,320   |
|   | <input type="checkbox"/> Power Kit, Complete (Ea.)                |              | 3        | 861150   | \$1,588   |
|   | <input type="checkbox"/> Power Kit, Complete (Ea.)                |              | 4        | 861160   | \$1,588   |
|  | <input type="checkbox"/> Plug for USA/Canada (Ea.)                |              | One Size | 2222166  | \$26      |
|  | <input type="checkbox"/> Batteries for Caribou with Power (Pr.) ♦ |              | One Size | 2222012  | \$305     |
| ♦ <b>Both batteries must be charged at the same time</b>                            |   |              |          |          |           |

HCPCS codes are provided for your convenience and are NOT to be considered billing or legal advice. Providers are responsible for insuring that all appropriate billing codes are used when submitting claims. Proper use of HCPCS codes does not insure coverage or payment. Contact the appropriate payer for coverage information.

**For shipping rates, please call 1-844-876-6245**

12801 E Independence Blvd, Matthews, NC 28105 • 1-844-876-6245 • Web: www.r82.com

Prices in USD & is subject to change without notice