

R82 Heron

CAD Retail Price List/ Order Form



Account #: _____ Purchase Order No.: _____ Date: _____
 Contact: _____ Mark For: _____

Bill To:	Ship To:
Address:	Address:
City/State/Zip:	
Phone:	City/State/Zip:
Email	Phone:

US Configuration

Effective: 12.07.18 - Rev 2

- Heron
- Head support
- Back support
- Swing away side support
- Arm rest/tray
- Foot and hip supports
- Commode pan
- Splash guard
- Vests and belts



- A (Back height) _____
- B (Arm height) _____
- C (Lower leg length) _____
- D (Seat depth) _____
- E (Chest width) _____
- F (Seat width) _____
- G (Height from seat to top of head) _____
- H (Shoulder width) _____
- Age _____
- Weight _____

Measurements

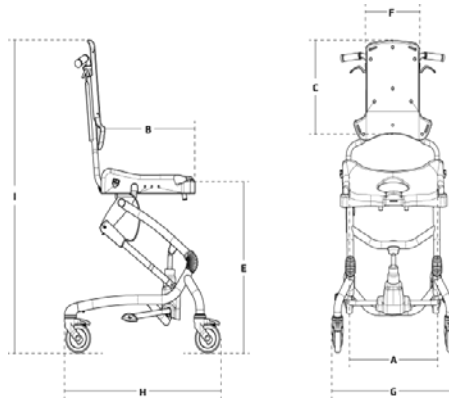

Heron

Seat width (A)	21¾"
Seat width with hip supports (accessories)	13¾"-19¼"
Seat depth (B)	17¾"
Seat depth with reduction kit (accessories)	15¾"
Back height (C)	21¾"-24½"
Lower leg length (D)	15¾"-22"
Seat height above floor (E)	20-30¾"
Back width (F)	11½"
Width, frame (G)	26½"
Length, frame (H)	28"
Height, frame w/seat (I)	42½"-53¼"
Seat angling (tilt in space)	-5° to +25°
Back angling	90° to +120°
Weight, without arm rests	61.5 lbs.
Max. Load/user weight	220.4 lbs.

Heron Standard Features

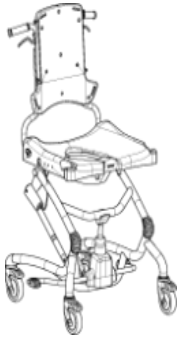

- One size
- 4 grey castors with locks
- Stainless steel frame
- Height adjustable frame
- Integrated push handles
- Built-in tilt in space
- Built-in recline
- Active, height adjustable back
- Potty ring

Description	Size	Part No.	CAD Price
<input type="checkbox"/> Heron	One Size	880505-01	\$6,547

Accessories	Description	Measurements	Size	Part No.	CAD Price
-------------	-------------	--------------	------	----------	-----------

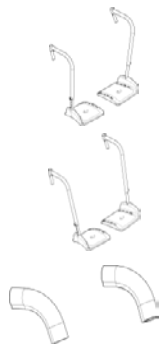

<input type="checkbox"/> Foot Support, Right-Angled Knee (Pr.) <i>(lower leg range: 15 1/2"-22")</i>	One Size	880506-01	\$617
<input type="checkbox"/> Foot Support, Open Knee Angle (Pr.) <i>(lower leg range: 15 1/2"-22")</i>	One Size	880506-02	\$617
<input type="checkbox"/> Padding for Foot Supports (Pr.)	One Size	880506-12	\$81

Description	Size	Part No.	CAD Price
-------------	------	----------	-----------

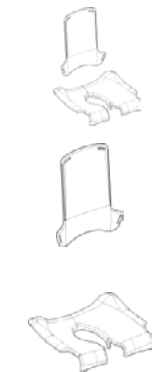

<input type="checkbox"/> Upholstery, Complete (Set)	One Size	880507-01	\$368
<input type="checkbox"/> Upholstery, Back Only (Ea.)	One Size	101204	\$181
<input type="checkbox"/> Upholstery, Seat Only (Ea.)	One Size	117005	\$202

Description	Size	Part No.	CAD Price
-------------	------	----------	-----------







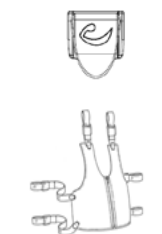



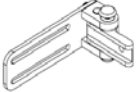

<input type="checkbox"/> Armrest, Swing-Away (Pr.)	2 x 14 1/2 x 9 3/4"	One Size	880508-03	\$605
--	---------------------	----------	-----------	-------

Description	Size	Part No.	CAD Price
-------------	------	----------	-----------



<input type="checkbox"/> Fix-Locks, White, Bag of 4 Pcs ** **Required for use of Vests	One Size	890505-36	\$50
<input type="checkbox"/> Vest	3	89111-340	\$249
<input type="checkbox"/> Vest	4	89111-440	\$249
<input type="checkbox"/> Neoprene Hip-Belt	2	85423-2	\$121

Accessories	Description	Measurements	Size	Part No.	CAD Price
	<input type="checkbox"/> Sides/Wings (Pr.)	4 x 14"	One Size	880508-01	\$106
	<input type="checkbox"/> Upholstery for Sides/Wings (Pr.)	4 x 14"	One Size	880507-04	\$106
	<input type="checkbox"/> Hip Supports (Pr.) <i>(seat width range: 13 ½"-22")</i>	8¼"W x 4"H	One Size	880508-02	\$393
<hr/>					
	Description	Measurements	Size	Part No.	CAD Price
	<input type="checkbox"/> Swing-Away Bracket, Stainless, Right (Ea.)		One Size	83000-R	\$281
	<input type="checkbox"/> Swing-Away Bracket, Stainless, Left (Ea.)		One Size	83000-L	\$281
	<input type="checkbox"/> Bar, Straight, Stainless (Ea.)	6¼"	One Size	82648	\$0
	<input type="checkbox"/> Cushion, Curved (Ea.)	3½ x 7½"	One Size	6175407	\$131
	<input type="checkbox"/> Cushion, Curved (Ea.)	2½ x 6½"	One Size	6175408	\$131
	<input type="checkbox"/> Cushion, Curved (Ea.)	2½ x 5¾"	One Size	6175409	\$131
	<input type="checkbox"/> Protection Pads (Ea.)		One Size	89151	\$115
<hr/>					
	Description	Measurements	Size	Part No.	CAD Price
	<input type="checkbox"/> Headrest 2, Grey		One Size	6172000	\$256
	<input type="checkbox"/> Headrest 3, Grey		One Size	6173000	\$256
	<input type="checkbox"/> Headrest 4, Grey		One Size	6174000	\$256
<hr/>					
Swing-away Mounting Brackets - Height, Depth, Angle and Lateral Adjustable					
	<input type="checkbox"/> Stainless Turtle Bar System		One Size	98619-24	\$287
	<input type="checkbox"/> Stainless Bar System, Straight ..	9"	One Size	87583	\$287
	<input type="checkbox"/> Stainless Bar System, Straight ..	14½"	One Size	87585	\$287
	<input type="checkbox"/> Stainless Swan Neck ..	7½ x 4"	One Size	87580	\$249
	<input type="checkbox"/> Stainless Swan Neck ..	13½ x 7¾"	One Size	87582	\$306
<i>..Custom order; Approx. lead time: 6-8 weeks.</i>					
<hr/>					
	Description	Measurements	Size	Part No.	CAD Price
	<input type="checkbox"/> Tray; Mounted in Armrest	17¼ x 7½"	One Size	880508-04	\$393
<hr/>					
	Description	Measurements	Size	Part No.	CAD Price
	<input type="checkbox"/> Commode Pan	7¾ x 13½ x 4¾"	One Size	880130	\$64
	<input type="checkbox"/> Lid for Commode Pan		One Size	880130-L	\$81
	<input type="checkbox"/> Splash Guard	3 x 5¼"	One Size	880508-05	\$87
	<input type="checkbox"/> Splash Guard, Low ..		One Size	880508-07	\$80
<i>..Custom order; Approx. lead time: 6-8 weeks.</i>					

Accessories	Description	Measurements	Size	Part No.	CAD Price
	<input type="checkbox"/> Calf Support, Strap (Ea.)	4"	One Size	880509-01	\$81
	<input type="checkbox"/> Heel Stops, Straps (Pr.)	1½"	One Size	880509-02	\$150
	<input type="checkbox"/> Shock Absorber, WhiteCustom order; Approx. lead time: 6-8 weeks.		One Size	116924-KIT	\$47

Spare Parts	Description	Measurements	Size	Part No.	CAD Price
	<input type="checkbox"/> Potty Ring		One Size	109072	\$54

HCPCS codes are provided for your convenience and are NOT to be considered billing or legal advice. Providers are responsible for insuring that all appropriate billing codes are used when submitting claims. Proper use of HCPCS codes does not insure coverage or payment. Contact the appropriate payer for coverage information.

For shipping rates, please call 1-844-876-6245

12801 E Independence Blvd, Matthews, NC 28105 • 1-844-876-6245 • Web: www.r82.com

Prices in CAD & is subject to change without notice

For Quotes and Orders please send completed Order Form to: us.info@r82.com