

# R82 Crocodile - E8000

## USD Retail Price List/ Order Form

Account #: \_\_\_\_\_ Purchase Order No.: \_\_\_\_\_ Date: \_\_\_\_\_  
 Contact: \_\_\_\_\_ Mark For: \_\_\_\_\_

Bill To:	Ship To:
Address:	Address:
City/State/Zip:	
Phone:	City/State/Zip:
Email	Phone:

**US Configuration**

**Effective: 08.17.20 - Rev 3**

- Crocodile
- Anti-tips
- Seat
- Hip supports
- Arm supports

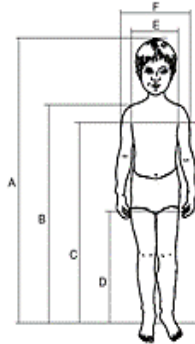

A (Total Height) \_\_\_\_\_  
 B (Shoulder Height) \_\_\_\_\_  
 C (Chest Height) \_\_\_\_\_  
 D (Buttock Height) \_\_\_\_\_  
 E (Chest Width) \_\_\_\_\_  
 F (Shoulder Width) \_\_\_\_\_  
 Age \_\_\_\_\_  
 Weight \_\_\_\_\_

**Measurements**

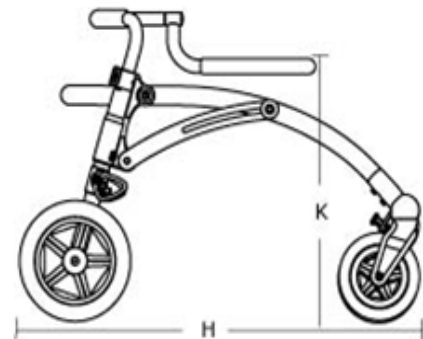
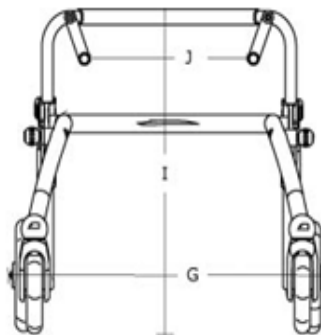

	<b>Starter Kit My First Steps Inches</b>	<b>Size 1 Inches</b>	<b>Size 2 Inches</b>	<b>Size 3 Inches</b>
Width, Between handles (J)	3½-10"	7½-13½"	12½ - 23½"	13½-25¼"
Height, Floor to handles (K)	15 - 27 ½"	16½-28¼"	21¾-33"	29½-41¼"
Width, Max (G)	24½"	24½"	27¼"	27¼"
Length, Standard (H)	26"	28¼"	33"	34¼"
Height - Floor to Top Frame (I)	20½-30"	20½-30"	22¼-33"	32¾-43"
Length, Folded	28"	28"	33½"	39½"
Height, Folded	12"	12"	10½"	11"
Weight, Standard	12 lbs.	12 lbs.	14 lbs.	26½ lbs.
User Height, Maximum	42¼"	42¼"	59"	70¾"
User Weight, Maximum	66 lbs.	66 lbs.	99 lbs.	176¼ lbs.
Turning Radius	39¼"	39¼"	45"	45"

## Crocodile Standard Features

### Size 1 & 2

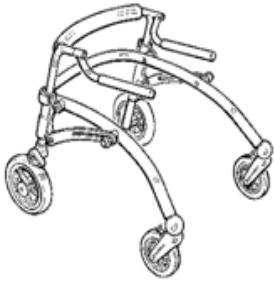



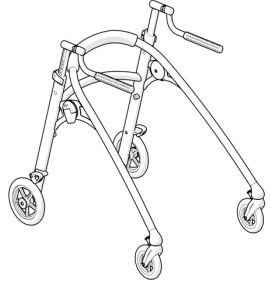



### Size 3











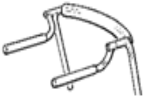

- Width & Height Adjustable Rotation Handles
- Easy to Fold
- Lightweight Durable Aluminum Frame (sz 1 and 2)
- Stable Steel & Aluminum Frame (sz 3)
- Upholstery & Cover for Top Frame
- Solid Front & Rear Wheels
- Swivel Front Casters with Castor Locks
- Adjustable Rear Drag Wheels
- On/Off Anti-Reverse Wheel Stop (Prevents Unit from Rolling Backwards)
- Padded Rear Stabilizer Bar with Tool Kit

Description	Size	Part No.	USD Price	HCPCS
<input type="checkbox"/> Crocodile Gait Trainer, Standard Yellow	1	86801	\$740	E8000
<input type="checkbox"/> Crocodile Gait Trainer, Orange	2	86802	\$740	E8000
<input type="checkbox"/> Crocodile Gait Trainer, Black	2	86852	\$740	E8000
<input type="checkbox"/> Crocodile Gait Trainer, Metallic Grey ♦	3	86803	\$1,220	E8000
♦ Crocodile sz 3 requires Cross Bar for Back Support				

Accessories	Description	Measurements	Size	Part No.	USD Price	HCPCS
	<input type="checkbox"/> Starter Kit Hand Brace Assy* *Allows lower handle height & width	15" - 27 1/2"	1	86801-0	\$350	
	<input type="checkbox"/> Forearm Support w/Handgrip (Pr.)	L:5 3/4 x W:3"	1	86858	\$370	
	<input type="checkbox"/> Forearm Support w/Handgrip (Pr.)	L:7 x W:4"	2	86859	\$370	
	<input type="checkbox"/> Forearm Support w/Handgrip (Pr.)		3	86860	\$370	
	<input type="checkbox"/> Padded Forearm Positioner (Ea.)		One Size	869370	\$68	
	<input type="checkbox"/> Pelvic Pad w/Lateral (Ea.) ♦	3 1/2" x 4 3/4" - 9"	Small	86808	\$262	
	<input type="checkbox"/> Pelvic Pad w/Lateral (Ea.) ♦	3 1/2" x 7" - 11 1/2"	Large	86809	\$262	
♦ Required with Sling Seat Lightweight						
	<input type="checkbox"/> Lateral Strap for Pelvic Pad (Ea.) ♦		One Size	905011	\$51	
♦ Required with Sling Seat Lightweight						
	<input type="checkbox"/> Back Support, Angle and Width Adj. ♦	9 1/2" - 11 1/2" x 7"	3	86886	\$505	
♦ Crossbar Required (86880)						
	<input type="checkbox"/> Back Support Strap, Small (Ea.) ♦	11 1/2" x 3"	3	85490-1	\$87	
	<input type="checkbox"/> Back Support Strap, Large (Ea.) ♦	13 1/2" x 4"	3	85490-2	\$87	
♦ For Back Support (86886)						
	<input type="checkbox"/> Cross Bar for Back Support (Ea.) ♦		3	86880	\$97	
♦ Required with Back Support (86886)						
	<input type="checkbox"/> Sling Seat, Lightweight (Ea.) ♦	23 1/2" (Waist)	1	86824-1	\$135	
	<input type="checkbox"/> Sling Seat, Lightweight (Ea.) ♦	27 1/4" (Waist)	2	86825-1	\$135	
♦ Requires Pelvic Pad w/ Laterals Small or Large and Lateral Strap						
	<input type="checkbox"/> Sling Seat (Ea.)	23 1/2" (Waist)	1	86824	\$135	
	<input type="checkbox"/> Sling Seat (Ea.)	27 1/4" (Waist)	2	86825	\$135	

Accessories	Description	Measurements	Size	Part No.	USD Price	HCPCS
	<input type="checkbox"/> Solid Seat, Yellow (Ea.)*	11½" (Seat to Floor Height)	1	86820	\$170	
	<input type="checkbox"/> Solid Seat, Orange (Ea.)*	16¾" (Seat to Floor Height)	2	86821	\$170	
	<input type="checkbox"/> Solid Seat, Black (Ea.)*	16¾" (Seat to Floor Height)	2	86823	\$170	
	<input type="checkbox"/> Solid Seat, Metallic Grey (Ea.)*	22" (Seat to Floor Height)	3	86863	\$170	
	<b>*Can Not be used with Starter Kit</b>					
	<input type="checkbox"/> Handle Knobs (Pr.)		All Sizes	86861	\$51	
	<input type="checkbox"/> Anti-Tip Device, Swing-Away (Pr.)		1, 2	86815	\$160	
	<input type="checkbox"/> Anti-Tip Device, Swing-Away (Pr.)		3	86815-3S	\$160	
	<input type="checkbox"/> Anti-Tip Device, Fixed (Pr.)		1, 2	86815-F	\$77	
	<input type="checkbox"/> Anti-Tip Device, Fixed (Pr.)		3	86815-3F	\$77	
	<input type="checkbox"/> Hand Brake*		1, 2	86834	\$240	
	<input type="checkbox"/> Hand Brake*		3	86873	\$240	
	<b>* If mounting vertically on forearm support, will require custom order.</b>					
	<input type="checkbox"/> Attendant Guide Bar (Ea.)		1, 2	86866	\$120	
	<input type="checkbox"/> Storage Bag (Ea.) ♦	7" x 11"	1, 2	86839	\$71	
	<input type="checkbox"/> Storage Bag (Ea.) ♦	11" x 14"	3	86843	\$210	
	<b>♦ Sz 1 &amp; 2 has 6½ lbs. weight limit, sz 3 has a 11 lbs. weight limit</b>					

Spare Parts	Description	Measurements	Size	Part No.	USD Price	HCPCS
	<input type="checkbox"/> Cover for Top Frame		1	86813	\$87	
	<input type="checkbox"/> Cover for Top Frame		2	86814	\$87	
	<input type="checkbox"/> Cover for Top Frame		3	86883	\$87	
	<input type="checkbox"/> Handle		1, 2	86833-TD	\$115	
	<input type="checkbox"/> Handle		3	86862	\$110	
	<input type="checkbox"/> Cover for Handle, Version 1-4		1, 2	2500520	\$22	
	<input type="checkbox"/> Cover for Handle, Version 5		1, 2	2500530	\$33	
	<input type="checkbox"/> Cover for Handle		3	2500520	\$22	
	<input type="checkbox"/> Standard Upper Handbrace Assy. 16 ½" - 28"		1	100783-1	\$430	
	<input type="checkbox"/> Standard Upper Handbrace Assy. 21 ½" - 33"		2	100783-2	\$430	
	<input type="checkbox"/> Knob for Folding Mechanism (Ea.)		1, 2	3470393	\$21	
	<input type="checkbox"/> Lock Parts for Handle Bar (Pr.)		1, 2	86831	\$16	
	<input type="checkbox"/> Lock Part for Handle and Cross Bar (Ea.)		3	86831-3U	\$21	

Spare Parts	Description	Qty	Size	Part No.	USD Price	HCPCS
	<input type="checkbox"/> On/Off Anti-Reverse Wheel Stop	_____	1, 2	86828	\$48	
	<input type="checkbox"/> On/Off Anti-Reverse Wheel Stop	_____	3	86828-3U	\$46	
	<input type="checkbox"/> Front Fork, Right	_____	1, 2	86837-H	\$155	
	<input type="checkbox"/> Front Fork, Left	_____	1, 2	86837-V	\$155	
	<input type="checkbox"/> Front Fork, Right	_____	3	86837-3H	\$155	
	<input type="checkbox"/> Front Fork, Left	_____	3	86837-3V	\$155	
	<input type="checkbox"/> Front Wheel, Universal (Ea.)	_____	One Size	86838	\$59	
	<input type="checkbox"/> Rear Wheel, Right, Complete	_____	1, 2	86835-1HM	\$240	
	<input type="checkbox"/> Rear Wheel, Left, Complete	_____	1, 2	86835-1VM	\$240	
	<input type="checkbox"/> Rear Wheel, Right, Complete	_____	3	86835-2HM	\$240	
	<input type="checkbox"/> Rear Wheel, Left, Complete	_____	3	86835-2VM	\$240	
	<input type="checkbox"/> Rear Wheel	_____	One Size	8000102	\$75	

HCPCS codes are provided for your convenience and are NOT to be considered billing or legal advice. Providers are responsible for insuring that all appropriate billing codes are used when submitting claims. Proper use of HCPCS codes does not insure coverage or payment. Contact the appropriate payer for coverage information.

Prices in USD & is subject to change without notice

**For Quotes and Orders please send completed Order Form to: [sales.us@etac.com](mailto:sales.us@etac.com) or fax: 1-800-760-0537**

Etac  
13137 Bleinheim Lane  
Matthews, North Carolina 28105  
+1 844-US-MOBILITY (844-876-6245)  
[www.etac.us.com](http://www.etac.us.com)

  
Creating Possibilities