

# R82 Toucan - E0638

## USD Retail Price List/ Order Form

Account #: \_\_\_\_\_ Purchase Order No.: \_\_\_\_\_ Date: \_\_\_\_\_  
 Contact: \_\_\_\_\_ Mark For: \_\_\_\_\_

Bill To:	Ship To:
Address:	Address:
City/State/Zip:	
Phone:	City/State/Zip:
Email	Phone:

### US Configuration

Effective: 05.01.21 Rev 3

- Toucan
- Footplate/Extra Foot Adj.
- Knee Support
- Hip/Side Support
- Back Support
- Chest Support
- Tray
- Head Support

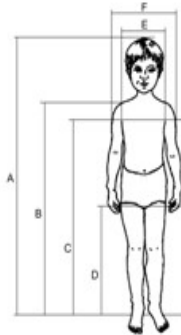

- A (Total Height) \_\_\_\_\_
- B (Shoulder Height) \_\_\_\_\_
- C (Chest Height) \_\_\_\_\_
- D (Buttock Height) \_\_\_\_\_
- E (Chest Width) \_\_\_\_\_
- F (Shoulder Width) \_\_\_\_\_
- Age \_\_\_\_\_
- Weight \_\_\_\_\_

### Measurements

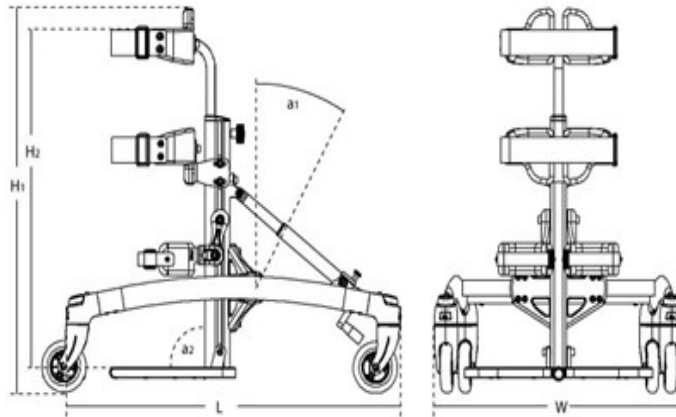

	Size 1 Inches	Size 2 Inches	Size 3 Inches	Size 4 Inches	Size 5 Inches
Width (G)	21¼"	24½"	24½"	27¼"	27¼"
Length (H)	29¼"	34¼"	34¼"	43¼"	43¼"
Total height (I1) *	26¼"-34"	28-39½"	37¾-48"	40½"-52¼"	48¼"-60"
Height from foot/chest (I2)	13¼"-27¼"	21-35"	29-43"	35½"-47¼"	43¼"-55"
Length, center bar	17½"	19½"	27½"	31¼"	39"
From floor to foot plate	2¼"	2¼"	2¼"	2½"	2½"
Angle of the center bar (a1)	0° to +30°	0° to +30°	0° to +30°	0° to +20°	0° to +20°
Angle of the foot plate (a2)	+15° to -10°	+15° to -10°	+15° to -10°	+15° to -10°	+15° to -10°
Weight	16½ lbs.	8½ lbs.	20 lbs.	10½ lbs.	24 lbs.
Max. user weight	67 lbs.	89 lbs.	111 lbs.	132 lbs.	154 lbs.
Approx. min. user height	24"	32"	42"	50½"	58½"
Approx. max. user height	38½"	42½"	56½"	62½"	71"

## Toucan Standard Features

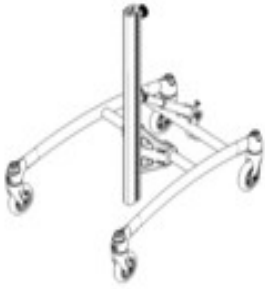





- Frame
- Castors
- Wheel Locks
- Center Bar
- Tilt Wind System

Description	Size	Part No.	USD Price	HCPCS
<input type="checkbox"/> Toucan Standing Frame, Red	1	861001	\$1,307	E0638
<input type="checkbox"/> Toucan Standing Frame, Blue	2	861002	\$1,307	E0638
<input type="checkbox"/> Toucan Standing Frame, Blue	3	861003	\$1,307	E0638
<input type="checkbox"/> Toucan Standing Frame, Silver	4	861004	\$1,456	E0638
<input type="checkbox"/> Toucan Standing Frame, Silver	5	861005	\$1,456	E0638







Accessories	Description	Measurements	Size	Part No.	USD Price	HCPCS
	<input type="checkbox"/> Chest Support	11" x 15½" x 7½"	1	861704	\$210	
	<input type="checkbox"/> Chest Support **	11" x 20-27" x 7½"	2, 3	861702	\$210	
	<input type="checkbox"/> Chest Support **	16" x 25-32" x 10½"	4, 5	861703	\$231	
	<b>**Height and width adjustable</b>					
	<input type="checkbox"/> Chest Support (Pony Style) **	5½" x 8¾" x 4¾"	1	861801	\$302	
	<input type="checkbox"/> Chest Support (Pony Style) **	5½" x 10¾" x 4¾"	2, 3	861802	\$302	
	<input type="checkbox"/> Chest Support (Pony Style) **	5½" x 12¾" x 4¾"	4	861803	\$302	
	<b>**Thicker Pad</b>					
	<input type="checkbox"/> Chest Support (Mustang Style) **	15½"-25¼"	Small	861810	\$502	
	<input type="checkbox"/> Chest Support (Mustang Style) **	26¼"-30¾"	Medium	861820	\$523	
	<input type="checkbox"/> Chest Support (Mustang Style) **	34¼"-44¾"	Large	861830	\$554	
	<b>**Surrounding Pad Style</b>					
	<input type="checkbox"/> Extra Pad	H:4¾" x W:2¼"	One Size	869225	\$63	
	<b>For Mustang Style Chest Support</b>					
	<input type="checkbox"/> Cover for Chest Support		Small	869810-160	\$118	
	<input type="checkbox"/> Cover for Chest Support		Medium	869820-260	\$144	
	<input type="checkbox"/> Cover for Chest Support **		Large	869830-360	\$154	
	<b>**Custom order; Approx. lead time: 6-8 weeks (sz Large)</b>					

Description	Measurements	Size	Part No.	USD Price	HCPCS
<input type="checkbox"/> Filler Pad	4¼"	Small	861421	\$84	
	<b>Adds 1" expansion to chest or hip pads</b>				
<input type="checkbox"/> Filler Pad	6¼"	Large	861422	\$84	
	<b>Adds 2" expansion to chest or hip pads</b>				
<input type="checkbox"/> Tray with Storage Box		One Size	862501	\$405	
<input type="checkbox"/> Height Adjustment of Tray		One Size	862510	\$231	

Accessories	Description	Measurements	Size	Part No.	USD Price	HCPCS
	<input type="checkbox"/> Tray, Plastic, w/Bowl and Plate	24" x 22½"	1	861121	\$518	
	<input type="checkbox"/> Tray, Plastic, w/Bowl and Plate	24" x 22½"	2	861122	\$518	
	<input type="checkbox"/> Tray, Plastic, w/Bowl and Plate	24" x 22½"	3	861123	\$518	
	<input type="checkbox"/> Tray, Plastic, w/Bowl and Plate	24" x 22½"	4	861124	\$518	
	<input type="checkbox"/> Tray, Plastic, w/Bowl and Plate	24" x 22½"	5	861125	\$518	
	<input type="checkbox"/> Armrest for Plastic Tray w/ Bowl	9½" x 12½"	One Size	861131	\$164	
	<input type="checkbox"/> Toy Bar for Plastic Tray w/ Bowl		One Size	861135	\$246	
	<input type="checkbox"/> Grip Handle		One Size	8910750	\$415	
	<b>*Custom order; Approx. lead time: 6-8 weeks. Non-returnable item</b>					
	<input type="checkbox"/> Tray, Plastic, Grey		One Size	862515	\$395	

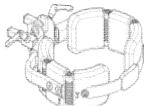
Description	Measurements	Size	Part No.	USD Price	HCPCS
-------------	--------------	------	----------	-----------	-------

**All Hip Supports include a strap**

	<input type="checkbox"/> Hip Support w/ Pommel ♦	4¼" x 6" x 3"	1	861501	\$518	
	<input type="checkbox"/> Hip Support w/ Pommel •	4¼" x 8-10½" x 3"	2, 3	861502	\$518	
	<input type="checkbox"/> Hip Support w/ Pommel •	6¼" x 10-11½" x 4"	4	861503	\$574	
	♦ <b>Height Adjustable</b>					
	• <b>Height and Width Adjustable</b>					
	<input type="checkbox"/> Hip Support, Front Mount ♦	4¼" x 6" x 3"	1	861601	\$241	
	<input type="checkbox"/> Hip Support, Front Mount •	4¼" x 8-10½" x 3"	2, 3	861602	\$241	
	<input type="checkbox"/> Hip Support, Front Mount •	6¼" 10-11½" x 4"	4	861603	\$272	
	♦ <b>Height Adjustable</b>					
	• <b>Height and Width Adjustable</b>					
	<input type="checkbox"/> Hip Support w/Rotation ♦	4¼" x 6" x 3"	1	861611	\$364	
	<input type="checkbox"/> Hip Support w/Rotation •	4¼" x 8-10½" x 3"	2, 3	861612	\$364	
	<input type="checkbox"/> Hip Support w/Rotation •	6¼" x 10-11½" x 4"	4	861613	\$395	
	♦ <b>Height Adjustable</b>					
	• <b>Height and Width Adjustable</b>					
	<input type="checkbox"/> Hip Support, Surrounding ••		1	861610	\$569	
	<input type="checkbox"/> Hip Support, Surrounding		2, 3	861620	\$569	
	<input type="checkbox"/> Hip Support, Surrounding ••		4	861630	\$579	
	•• <b>Custom Order; Approx. lead time: 6-8 weeks.</b>					
	<input type="checkbox"/> Extension for Center Bar (Ea.)	3¼"	One Size	861480	\$84	
	<input type="checkbox"/> Abdominal Support (Ea.)	5" x 7½"	One Size	861411	\$164	
	<input type="checkbox"/> Pommel and Sacral Support (Ea.)	5" x 7½"	One Size	861401	\$446	

Accessories	Description	Measurements	Size	Part No.	USD Price	HCPCS
-------------	-------------	--------------	------	----------	-----------	-------

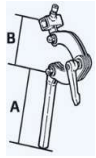

**Swing-away Mounting Brackets - Height, Depth, Angle and Lateral Adjustable**

- Turtle Bar System ♦ A: 5", B: 4-8½" Short 98619-25 \$236
  - Turtle Bar System ♦ A: 10", B: 4-8½" Long 98619-26 \$236
- ♦Required with Anatomic Head Support; 5099001, 5099002 or 5099003

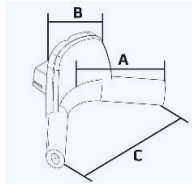

- Anatomic Head Support ♦ A:5½ x B:5½ x C:9½" Small 5099001 \$261
  - Head Support Cover (Required) Small 9923-83 N/C
  - Anatomic Head Support ♦ A:6 x B:5½ x C:10" Medium 5099002 \$261
  - Head Support Cover (Required) Medium 9945-83 N/C
  - Anatomic Head Support ♦ A:6½ x B:5½ x C:12½" Large 5099003 \$261
  - Head Support Cover (Required) Large 9967-83 N/C
- ♦Turtle Bar System Short or Long Required; 98619-25 or 98619-26

Other types of headrest available, please see Head Supports Order Form

Description	Measurements	Size	Part No.	USD Price	HCPCS
-------------	--------------	------	----------	-----------	-------



- Knee Supports (Pr.) ♦ 2½" x 2½" 1 861301 \$287
  - Knee Supports (Pr.) ♦ 2¾" x 3¼" 2, 3 861302 \$364
  - Knee Supports (Pr.) ♦ 2¾" x 4" 4, 5 861303 \$364
- ♦Includes Straps



- Hinged Knee Supports (Pr.) ♦ 3" 1 861311 \$446
  - Hinged Knee Supports (Pr.) ♦ 3¾" 2, 3 861312 \$446
  - Hinged Knee Supports (Pr.) ♦ 4½" 4, 5 861313 \$446
- ♦Includes Straps



- Individual Footrest w/Hinged Sandals ♦ 1 861201 \$405
  - Individual Footrest w/Hinged Sandals ♦ 2, 3 861202 \$405
- ♦Includes Straps

Accessories	Description	Measurements	Size	Part No.	USD Price	HCPCS
-------------	-------------	--------------	------	----------	-----------	-------



- Flip-up Footplate ♦ 12" x 12" 1 861211 \$226
  - Flip-up Footplate ♦ 17" x 14" 2, 3, 4, 5 861212 \$226
- ♦Required with all Footplate Accessories



- Formed Footplates (Pr.) ♦ 6¾" 0 86149 \$169
  - Formed Footplates (Pr.) ♦ 4" x 8½" 1, 2 86147 \$169
  - Formed Footplates (Pr.) ♦ 4½" x 9½" 3 86148 \$169
- ♦Flip-Up Footplate Required; 861211 or 861212

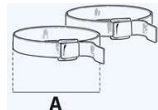

- Foot Straps, Plastic Lock (Pr.) Max: 22", A: 13½-20½" One Size 85096 \$37
- Foot Straps, Velcro (Pr.) One Size 85102 \$52







- Hinged Sandals w/Straps ♦ 3¾" x 8" 1 861221 \$138
  - Hinged Sandals w/Straps ♦ 4½" x 9½" 2, 3 861222 \$138
  - Hinged Sandals w/Straps ♦ 6" x 12" 4, 5 861223 \$138
- ♦Flip-Up Footplate Required; 861211 or 861212



- Heel Stop ♦ 1½" x 4" Small 861251 \$57
  - Heel Stop ♦ 4" x 5¾" Large 861252 \$57
- ♦Flip-Up Footplate Required; 861211 or 861212

Spare Parts	Description	Measurements	Size	Part No.	USD Price
	<input type="checkbox"/> Strap for Hip Support		1	861621	\$63
	<input type="checkbox"/> Strap for Hip Support		2, 3	861622	\$63
	<input type="checkbox"/> Strap for Hip Support		4, 5	861623	\$63

Spare Parts	Description	Measurements	Size	Part No.	USD Price
	<input type="checkbox"/> Kit for Center Bar ●●		2	861902	\$164
	<input type="checkbox"/> Kit for Center Bar ●●		3	861903	\$179
	<input type="checkbox"/> Kit for Center Bar ●●		4	861904	\$200
	<input type="checkbox"/> Kit for Center Bar ●●		5	861905	\$231
	<b>●●Custom order; Approx. lead time: 6-8 weeks</b>				

	<input type="checkbox"/> Mounting for Back Support		One Size	861451	\$136
	<input type="checkbox"/> Straps for Knee Supports (Pr.)		1	861341	\$57
	<input type="checkbox"/> Straps for Knee Supports (Pr.)		2, 3	861342	\$57
	<input type="checkbox"/> Straps for Flip-Up Footplate (Pr.)		1	861241	\$89
	<input type="checkbox"/> Straps for Flip-Up Footplate (Pr.)		2, 3	861242	\$89
	<input type="checkbox"/> Straps for Flip-Up Footplate (Pr.)		4, 5	861243	\$89

HCPCS codes are provided for your convenience and are NOT to be considered billing or legal advice. Providers are responsible for insuring that all appropriate billing codes are used when submitting claims. Proper use of HCPCS codes does not insure coverage or payment. Contact the appropriate payer for coverage information.

**Prices in USD & is subject to change without notice**  
**For Quotes and Orders please send completed Order Form to: [sales.us@etac.com](mailto:sales.us@etac.com) or Fax: 1-800-760-0537**

Etac  
13137 Bleinheim Lane  
Matthews, North Carolina 28105  
+1 844-US-MOBILITY (844-876-6245)  
[www.etac.us.com](http://www.etac.us.com)

OF6400-ENG-REV.03  
  
Creating Possibilities