

R82 Heron

USD Retail Price List/ Order Form

Account #: _____ Purchase Order No.: _____ Date: _____
 Contact: _____ Mark For: _____

| | |
|-----------------|-----------------|
| Bill To: | Ship To: |
| Address: | Address: |
| City/State/Zip: | |
| Phone: | City/State/Zip: |
| Email | Phone: |

US Configuration

Effective: 01.01.22 - Rev 4

- Heron
- Head support
- Back support
- Swing away side support
- Arm rest/tray
- Foot and hip supports
- Commode pan
- Splash guard
- Vests and belts



- A** (Back height) _____
- B** (Arm height) _____
- C** (Lower leg length) _____
- D** (Seat depth) _____
- E** (Chest width) _____
- F** (Seat width) _____
- G** (Height from seat to top of head) _____
- H** (Shoulder width) _____
- Age _____
- Weight _____

Measurements

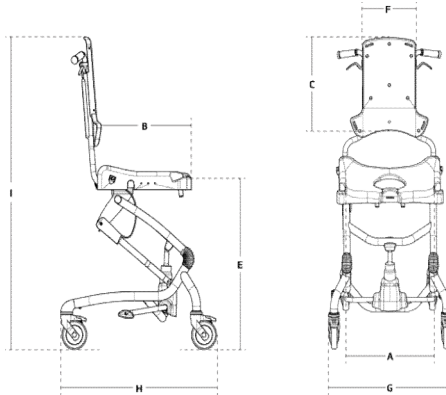

Heron

| | |
|---|--------------|
| Seat width (A) | 21¾" |
| Seat width with hip supports (accessories) | 13¾"-19¼" |
| Seat depth (B) | 17¾" |
| Seat depth with reduction kit (accessories) | 15¾" |
| Back height (C) | 21¾"-24½" |
| Lower leg length (D) | 15¾"-22" |
| Seat height above floor (E) | 20-30¾" |
| Back width (F) | 11½" |
| Width, frame (G) | 26½" |
| Length, frame (H) | 28" |
| Height, frame w/seat (I) | 42½"-53¼" |
| Seat angling (tilt in space) | -5° to +25° |
| Back angling | 90° to +120° |
| Weight, without arm rests | 61.5 lbs. |
| Max. Load/user weight | 220.4 lbs. |

Heron Standard Features

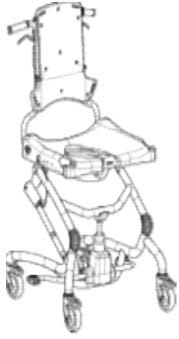

- One size
- 4 grey castors with locks
- Stainless steel frame
- Height adjustable frame
- Integrated push handles
- Built-in tilt in space
- Built-in recline
- Active, height adjustable back
- Potty ring

| Description | Size | Part No. | USD Price |
|--------------------------------|----------|-----------|-----------|
| <input type="checkbox"/> Heron | One Size | 880505-01 | \$5,475 |

| Accessories | Description | Measurements | Size | Part No. | USD Price |
|-------------|-------------|--------------|------|----------|-----------|
|-------------|-------------|--------------|------|----------|-----------|

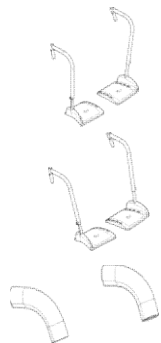

| | | | |
|---|----------|-----------|-------|
| <input type="checkbox"/> Foot Support, Right-Angled Knee (Pr.) <i>(lower leg range: 15 1/2"-22")</i> | One Size | 880506-01 | \$516 |
| <input type="checkbox"/> Foot Support, Open Knee Angle (Pr.) <i>(lower leg range: 15 1/2"-22")</i> | One Size | 880506-02 | \$516 |
| <input type="checkbox"/> Padding for Foot Supports (Pr.) | One Size | 880506-12 | \$68 |

| Description | Size | Part No. | USD Price |
|-------------|------|----------|-----------|
|-------------|------|----------|-----------|

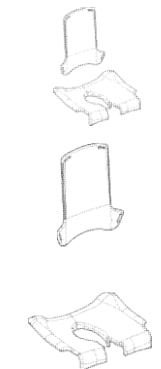

| | | | |
|--|----------|-----------|-------|
| <input type="checkbox"/> Upholstery, Complete (Set) | One Size | 880507-01 | \$307 |
| <input type="checkbox"/> Upholstery, Back Only (Ea.) | One Size | 101204 | \$152 |
| <input type="checkbox"/> Upholstery, Seat Only (Ea.) | One Size | 117005 | \$169 |

| Description | Size | Part No. | USD Price |
|-------------|------|----------|-----------|
|-------------|------|----------|-----------|





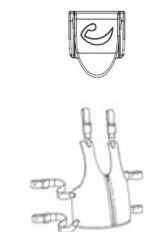

| | | | | |
|--|---------------------|----------|-----------|-------|
| <input type="checkbox"/> Armrest, Swing-Away (Pr.) | 2 x 14 1/2 x 9 3/4" | One Size | 880508-03 | \$506 |
|--|---------------------|----------|-----------|-------|

| Description | Size | Part No. | USD Price |
|-------------|------|----------|-----------|
|-------------|------|----------|-----------|

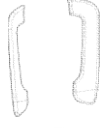

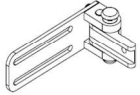
| | | | |
|--|----------|-----------|-------|
| <input type="checkbox"/> Fix-Locks, White, Bag of 4 Pcs ** **Required for use of Vests | One Size | 890505-36 | \$44 |
| <input type="checkbox"/> Vest | 3 | 89111-340 | \$209 |
| <input type="checkbox"/> Vest | 4 | 89111-440 | \$209 |
| <input type="checkbox"/> Neoprene Hip-Belt | 2 | 85423-2 | \$101 |

| Accessories | Description | Measurements | Size | Part No. | USD Price | |
|---|---|----------------|----------|-----------|-----------|-------|
|  | <input type="checkbox"/> Sides/Wings (Pr.) | 4 x 14" | One Size | 880508-01 | \$89 | |
|  | <input type="checkbox"/> Upholstery for Sides/Wings (Pr.) | 4 x 14" | One Size | 880507-04 | \$89 | |
|  | <input type="checkbox"/> Hip Supports (Pr.) <i>(seat width range: 13 1/2"-22")</i> | 8 1/4"W x 4"H | One Size | 880508-02 | \$329 | |
|  | <input type="checkbox"/> Swing-Away Bracket, Stainless, Right (Ea.) | | One Size | 83000-R | \$235 | E1028 |
|  | <input type="checkbox"/> Swing-Away Bracket, Stainless, Left (Ea.) | | One Size | 83000-L | \$235 | E1028 |
| | <input type="checkbox"/> Bar, Straight, Stainless (Ea.) | 6 1/4" | One Size | 82648 | \$0 | E1028 |
| | <input type="checkbox"/> Bar, Offset, 1" Stainless, (Ea.) | 4 3/4" | One Size | 150238 | \$0 | E1028 |
| | <input type="checkbox"/> Cushion, Curved (Ea.) | 3 1/2 x 7 1/2" | One Size | 6175407 | \$110 | E0956 |
| | <input type="checkbox"/> Cushion, Curved (Ea.) | 2 1/2 x 6 1/2" | One Size | 6175408 | \$110 | E0956 |
| | <input type="checkbox"/> Cushion, Curved (Ea.) | 2 1/2 x 5 3/4" | One Size | 6175409 | \$110 | E0956 |
| | <input type="checkbox"/> Protection Pads (Ea.) | | One Size | 89151 | \$96 | |

| Description | Measurements | Size | Part No. | USD Price | HPCPS |
|-------------|--------------|------|----------|-----------|-------|
|-------------|--------------|------|----------|-----------|-------|

| | | | | | |
|---|----------------|----------|---------|-------|-------|
| <input type="checkbox"/> Swing-Away Bracket, Stainless, Right (Ea.) | | One Size | 83000-R | \$235 | E1028 |
| <input type="checkbox"/> Swing-Away Bracket, Stainless, Left (Ea.) | | One Size | 83000-L | \$235 | E1028 |
| <input type="checkbox"/> Bar, Straight, Stainless (Ea.) | 6 1/4" | One Size | 82648 | \$0 | E1028 |
| <input type="checkbox"/> Bar, Offset, 1" Stainless, (Ea.) | 4 3/4" | One Size | 150238 | \$0 | E1028 |
| <input type="checkbox"/> Cushion, Curved (Ea.) | 3 1/2 x 7 1/2" | One Size | 6175407 | \$110 | E0956 |
| <input type="checkbox"/> Cushion, Curved (Ea.) | 2 1/2 x 6 1/2" | One Size | 6175408 | \$110 | E0956 |
| <input type="checkbox"/> Cushion, Curved (Ea.) | 2 1/2 x 5 3/4" | One Size | 6175409 | \$110 | E0956 |

| Description | Measurements | Size | Part No. | USD Price | HPCPS |
|-------------|--------------|------|----------|-----------|-------|
|-------------|--------------|------|----------|-----------|-------|

| | | | | | |
|---|--|----------|---------|-------|-------|
| <input type="checkbox"/> Headrest 2, Grey | | One Size | 6172000 | \$214 | E0955 |
| <input type="checkbox"/> Headrest 3, Grey | | One Size | 6173000 | \$214 | E0955 |
| <input type="checkbox"/> Headrest 4, Grey | | One Size | 6174000 | \$214 | E0955 |

Swing-away Mounting Brackets - Height, Depth, Angle and Lateral Adjustable

| | | | | | |
|--|--|----------|----------|-------|-------|
| <input type="checkbox"/> Stainless Turtle Bar System | | One Size | 98619-24 | \$240 | E0955 |
| <input type="checkbox"/> Stainless Bar System, Straight •• 9" | | One Size | 87583 | \$240 | E0955 |
| <input type="checkbox"/> Stainless Bar System, Straight •• 14 1/2" | | One Size | 87585 | \$240 | E0955 |
| <input type="checkbox"/> Stainless Swan Neck •• 7 1/2 x 4" | | One Size | 87580 | \$209 | E0955 |
| <input type="checkbox"/> Stainless Swan Neck •• 13 1/2 x 7 3/4" | | One Size | 87582 | \$255 | E0955 |

••Custom order; Approx. lead time: 6-8 weeks.

| Description | Measurements | Size | Part No. | USD Price |
|-------------|--------------|------|----------|-----------|
|-------------|--------------|------|----------|-----------|

| | | | | |
|---|-----------------|----------|-----------|-------|
| <input type="checkbox"/> Tray; Mounted in Armrest | 17 1/4 x 7 1/2" | One Size | 880508-04 | \$329 |
|---|-----------------|----------|-----------|-------|



| Description | Measurements | Size | Part No. | USD Price |
|-------------|--------------|------|----------|-----------|
|-------------|--------------|------|----------|-----------|

| | | | | |
|--|-------------------------|----------|----------|------|
| <input type="checkbox"/> Commode Pan | 7 3/4 x 13 1/2 x 4 3/4" | One Size | 880130 | \$53 |
| <input type="checkbox"/> Lid for Commode Pan | | One Size | 880130-L | \$68 |

| | | | | |
|---------------------------------------|------------|----------|-----------|------|
| <input type="checkbox"/> Splash Guard | 3 x 5 1/4" | One Size | 880508-05 | \$73 |
|---------------------------------------|------------|----------|-----------|------|

| | | | | |
|---|--|----------|-----------|------|
| <input type="checkbox"/> Splash Guard, Low •• | | One Size | 880508-07 | \$67 |
|---|--|----------|-----------|------|

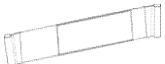
••Custom order; Approx. lead time: 6-8 weeks.

| Accessories | Description | Measurements | Size | Part No. | USD Price |
|---|--|--------------|----------|------------|-----------|
|  | <input type="checkbox"/> Calf Support, Strap (Ea.) | 4" | One Size | 880509-01 | \$68 |
|  | <input type="checkbox"/> Heel Stops, Straps (Pr.) | 1½" | One Size | 880509-02 | \$125 |
|  | <input type="checkbox"/> Shock Absorber, White ●● ●● <i>Custom order; Approx. lead time: 6-8 weeks.</i> | | One Size | 116924-KIT | \$40 |

| Spare Parts | Description | Measurements | Size | Part No. | USD Price |
|---|-------------------------------------|--------------|----------|----------|-----------|
|  | <input type="checkbox"/> Potty Ring | | One Size | 109072 | \$45 |

HCPCS codes are provided for your convenience and are NOT to be considered billing or legal advice. Providers are responsible for insuring that all appropriate billing codes are used when submitting claims. Proper use of HCPCS codes does not insure coverage or payment. Contact the appropriate payer for coverage information.

Prices in USD & is subject to change without notice
For Quotes and Orders please send completed Order Form to: us.info@r82.com

Etac
13137 Bleinheim Lane
Matthews, North Carolina 28105
+1 844-US-MOBILITY (844-876-6245)
www.etac.us.com

OF5500-ENG-REV.04

Creating Possibilities