

R82 Caribou - E0641

CAD Retail Price List/ Order Form



Account #: _____ Purchase Order No.: _____ Date: _____
 Contact: _____ Mark For: _____

Bill To:	Ship To:
Address:	Address:
City/State/Zip:	
Phone:	City/State/Zip:
Email	Phone:

US Configuration

Effective: 06/16/2018 - Rev 5

- Caribou
- Top Pad/Shoulder Support
- Cross Straps/Back Support
- Chest Strap
- Head Support
- Extra Cushion
- Hip/Side Support
- Knee Support/Pommel with Strap
- Tray

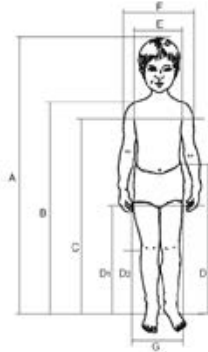

- A (Total Height) _____
- B (Shoulder Height) _____
- C (Chest Height) _____
- D (Top of Pelvis) _____
- D1 (Buttock Height) _____
- D2 (Below Knee) _____
- E (Chest Width) _____
- F (Shoulder Width) _____
- G (Pelvis Width) _____
- Age _____
- Weight _____

Measurements

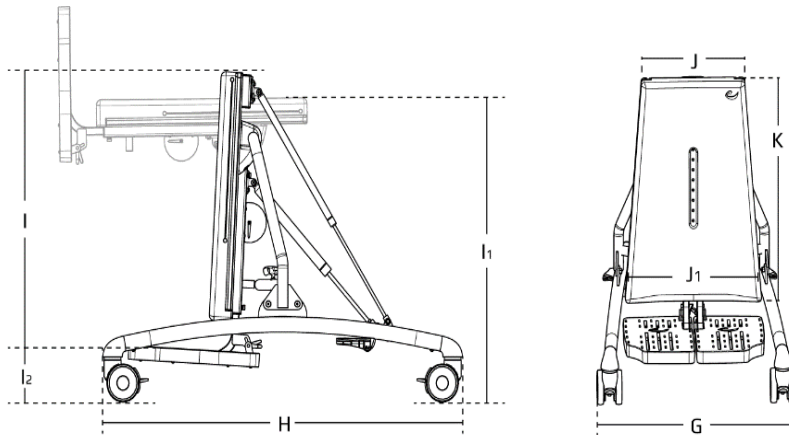

	Size 1 Inches	Size 2 Inches	Size 3 Inches	Size 4 Inches
Frame width (G)	20"	22½"	25½"	29¼"
Frame length (H)	29¼"	36"	43¼"	43¼"
Height, vertical (I)	18-22½"	20¾-25¼"	26¾-31"	34¾-39"
Height, horizontal (I1)	27½"	27½"	31½"	31½"
Height from floor to frame (I2)	5"	5"	5"	5"
Basis plate width, top-bottom (J-J1)	9¾-12½"	11¾-15"	13¾-18"	15¾-21¾"
Basis plate height (K)	17"	19¾"	25½"	33½"
Angling	0-87°	0-87°	0-87°	0-87°
Foot plate angling	-10-10°	-10-10°	-10-10°	-10-10°
Weight, wo/power	45.2 lbs.	53 lbs.	67.2 lbs.	77.2 lbs.
Weight, w/power	49.6 lbs.	56.2 lbs.	71.7 lbs.	81.6 lbs.
Max load	88.2 lbs.	132.3 lbs.	176.4 lbs.	220½"
Approximate total user height	22-42"	32-52"	42-60"	52-72"

Caribou Standard Features



- Sizes 1, 2, 3 and 4
- 4" Locking Castors
- Contoured Top Plate
- Tilt: From Vertical to Horizontal
- Height and Angle Adjustable 2-Piece Footrest

Description	Size	Part No.	CAD Price
-------------	------	----------	-----------

Important: For sizes 3 and 4 it is recommended to use the power version to ease the tilting; see below

<input type="checkbox"/> Caribou Base w/ 2-Piece Footrest	1	860101-FP	\$3,404
<input type="checkbox"/> Caribou Base w/ 2-Piece Footrest	2	860102-FP	\$3,529
<input type="checkbox"/> Caribou Base w/ 2-Piece Footrest	3	860113-FP	\$3,909
<input type="checkbox"/> Caribou Base w/ 2-Piece Footrest	4	860114-FP	\$4,545

Description	Size	Part No.	CAD Price
-------------	------	----------	-----------

<input type="checkbox"/> Caribou Base with Power Actuator ●●	1	860101-ELFP	\$5,312
<input type="checkbox"/> Caribou Base with Power Actuator ●●	2	860102-ELFP	\$5,437
<input type="checkbox"/> Caribou Base with Power Actuator	3	860103-ELFP	\$5,817
<input type="checkbox"/> Caribou Base with Power Actuator	4	860104-ELFP	\$6,453

●●Custom order; Approx. lead time: 6-8 weeks. Non-returnable item (Sz 1 and 2)

Description	Measurements	Size	Part No.	CAD Price
-------------	--------------	------	----------	-----------

Required, must select one:

<input type="checkbox"/> Top Pad ♦	W1:6, W2:7, H:7¼"	1	861101-1	N/C
<input type="checkbox"/> Top Pad ♦	W1:7½, W2:9, H:9¾"	2	861101-2	N/C
<input type="checkbox"/> Top Pad ♦	W1:8¾, W2:10½, H:12½"	3	861101-3	N/C
<input type="checkbox"/> Top Pad ♦	W1:9¾, W2:12¼, H:15¾"	4	861101-4	N/C

♦ Top Pad size must match Shoulder Support size

<input type="checkbox"/> Head Pad	W: 6", H: 7½"	1, 2	861116-1	\$630
<input type="checkbox"/> Head Pad	W: 8", H: 9½"	3, 4	861116-2	\$630

Description	Measurements	Size	Part No.	CAD Price
-------------	--------------	------	----------	-----------

<input type="checkbox"/> Extra Cushion (Ea.)	W:9¾" x H:3"	One Size	861106-1	\$287
<input type="checkbox"/> Extra Cushion (Ea.)	W:11¾ x H:4"	One Size	861106-2	\$287
<input type="checkbox"/> Extra Cushion (Ea.)	W:13¾ x H:4"	One Size	861106-3	\$312
<input type="checkbox"/> Extra Cushion (Ea.)	W:15¾ x H:4"	One Size	861106-4	\$312

Accessories	Description	Measurements	Size	Part No.	CAD Price
-------------	-------------	--------------	------	----------	-----------

■ XX = 60 (Black)

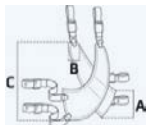



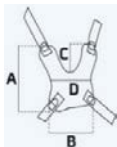





<input type="checkbox"/> Cross Vest (Ea.)	A: 5 x B:½ x C:12"	1	89625-1XX	\$237
<input type="checkbox"/> Cross Vest (Ea.)	A: 5½ x B:½ x C:13"	2	89625-2XX	\$237
<input type="checkbox"/> Cross Vest (Ea.)	A: 6¼ x B:2½ x C:15¼"	3	89625-3XX	\$237

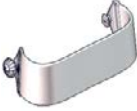

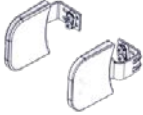

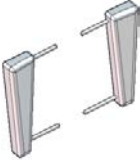

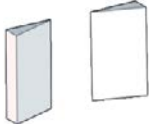



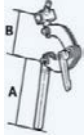
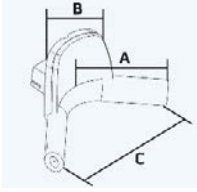

<input type="checkbox"/> Neoprene Vest (Ea.)	A:7 x B:5½ x C:4 x D:4½"	1	89113-1	\$249
<input type="checkbox"/> Neoprene Vest (Ea.)	A:10½ x B:11 x C:6½ x D:5¾"	2	89113-2	\$249
<input type="checkbox"/> Neoprene Vest (Ea.)	A:11¼ x B:9 x C:7 x D:6½"	3	89113-3	\$249



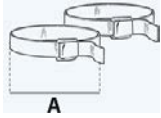

<input type="checkbox"/> Chest Belt, Upholstered (Ea.)		1	85428-1	\$337
<input type="checkbox"/> Chest Belt, Upholstered (Ea.)		2	85428-2	\$337
<input type="checkbox"/> Chest Belt, Upholstered (Ea.)		3	85428-3	\$337

Accessories	Description	Measurements	Size	Part No.	CAD Price
	<input type="checkbox"/> Fix-Locks, Black, Bag of 6 Pcs ♦ ♦ <i>Required for use of Vests</i>		One Size	862109-35	\$52
Other types of vests and belts available, please see Vest and Belts Order Form					
	<input type="checkbox"/> Chest Strap (Ea.)	W: 16½-24¾"	1, 2	862101-2	\$150
	<input type="checkbox"/> Chest Strap (Ea.)	W: 19-30¼"	3	862101-3	\$150
	<input type="checkbox"/> Chest Strap (Ea.)	W: 22¾-37¾"	4	862101-4	\$150
<i>Note: A chest strap is not included as standard, quantity of two straps is recommended.</i>					
	<input type="checkbox"/> Cross Straps (Pr.)	15-19¼"	1	862102-1	\$349
	<input type="checkbox"/> Cross Straps (Pr.)	17-21½"	2	862102-2	\$349
	<input type="checkbox"/> Cross Straps (Pr.)	20¾-27½"	3	862102-3	\$368
	<input type="checkbox"/> Cross Straps (Pr.) ♦♦	24¾-33¾"	4	862102-4	\$368
<i>♦♦Custom order; Approx. lead time: 6-8 weeks (Size 4)</i>					
	<input type="checkbox"/> Side Supports, Fixed, Type 7 (Pr.) Pad: 44.33 x 4.72"		1, 2	861102-10	\$312
	<input type="checkbox"/> Side Supports, Fixed, Type 5 (Pr.) Pad: 6.3 x 5.9"		3, 4	861102-20	\$374
	<input type="checkbox"/> Side Supports, size 1 (Pr.)	L: 5½ X H:5½ x W:3¾"	One Size	861102-1	\$355
	<input type="checkbox"/> Side Supports, size 2 (Pr.)	L: 6½ X H:7 x W:5"	One Size	861102-2	\$355
	<input type="checkbox"/> Side Supports, size 3 (Pr.)	L: 7¾ H:7 x W:5"	One Size	861102-3	\$355
<i>Width between laterals on torso pad (min-max)</i>					
	Size 1: 4" to 9"	Size 2: 6½" to 14"	Size 3: 12" to 18"		
	<input type="checkbox"/> Lateral Support Strap (Ea.)	10-12½"	1	862103-1	\$64
	<input type="checkbox"/> Lateral Support Strap (Ea.)	13-16"	2	862103-2	\$64
	<input type="checkbox"/> Lateral Support Strap (Ea.)	13½-19¾"	3	862103-3	\$64
	<input type="checkbox"/> Shoulder Support (Pr.) ♦	W:3, H:7½, D:2"	1	861126-1	\$318
	<input type="checkbox"/> Shoulder Support (Pr.) ♦	W:3¼ H:9¼, D:2"	2	861126-2	\$318
	<input type="checkbox"/> Shoulder Support (Pr.) ♦	W:4, H:12½, D:2"	3	861126-3	\$318
	<input type="checkbox"/> Shoulder Support (Pr.) ♦	W:4¼H:15¼ D:2"	4	861126-4	\$318
<i>♦ Shoulder Support size must match Top Pad size.</i>					
	<input type="checkbox"/> Upper Arm Support, Small		1, 2	861109-10	\$468
	<input type="checkbox"/> Upper Arm Support, Large		3, 4	861109-20	\$499
	<input type="checkbox"/> Wedges for Side Slots (Pr.) ♦♦		1	861107-1	\$20
	<input type="checkbox"/> Wedges for Side Slots (Pr.) ♦♦		2	861107-2	\$20
	<input type="checkbox"/> Wedges for Side Slots (Pr.) ♦♦		3	861107-3	\$20
<i>♦♦Custom order; Approx. lead time: 6-8 weeks (All Sizes)</i>					
	<input type="checkbox"/> Back Support (Ea.) ♦♦		1, 2	861115-2	\$368
	<input type="checkbox"/> Back Support (Ea.)		3, 4	861115-3	\$374
<i>♦♦Custom order; Approx. lead time: 6-8 weeks (Sizes 1 & 2)</i>					

Accessories	Description	Measurements	Size	Part No.	CAD Price
	<input type="checkbox"/> Turtle Bar System ♦ ♦ Required with all Head Supports	A: 10", B: 4-8½"	Long	98619-26	\$287
	<input type="checkbox"/> Anatomic Head Support ♦	A:5½ x B:5½ x C:9½"	Small	5099001	\$318
	<input type="checkbox"/> Head Support Cover (Required)		Small	9923-83	N/C
	<input type="checkbox"/> Anatomic Head Support ♦	A:6 x B:5½ x C:10"	Medium	5099002	\$318
	<input type="checkbox"/> Head Support Cover (Required)		Medium	9945-83	N/C
	<input type="checkbox"/> Anatomic Head Support ♦	A:6½ x B:5½ x C:12½"	Large	5099003	\$318
	<input type="checkbox"/> Head Support Cover (Required)		Large	9967-83	N/C
	♦ Turtle Bar System Short or Long Required; 98619-25 or 98619-26				
Other types of headrest available, please see Head Supports Order Form					
<hr/>					
Description	Measurements	Size	Part No.	CAD Price	
	<input type="checkbox"/> Pommel, Size 1 (Ea.)	W1:2,W2:2¾,H:6,D:3½"	One Size	861103-1	\$168
	<input type="checkbox"/> Pommel, Size 2 (Ea.)	W1:6,W2:2¾,H:6,D:6¾"	One Size	861103-2	\$168
	<input type="checkbox"/> Strap for Pommel, Sz 1 (Ea.) ♦♦	L:9.84 - 11.81"	One Size	862104-1	\$181
	<input type="checkbox"/> Strap for Pommel, Sz 2 (Ea.) ♦♦	L:10.63 - 18½"	One Size	862104-2	\$181
	♦♦ Custom order; Approx. lead time: 6-8 weeks				
	<input type="checkbox"/> Knee Support, Fixed, sz 1		1, 2	861144-2	\$480
	<input type="checkbox"/> Knee Support, Hinged, Fixed, sz 1 ♦♦		1, 2	861144-20	\$667
	<input type="checkbox"/> Knee Support, Fixed, sz 2 **		3, 4	861144-3	\$480
	<input type="checkbox"/> Knee Support, Hinged, Fixed, sz 2 ♦♦		3, 4	861144-30	\$667
	♦♦ Custom order; Approx. lead time: 6-8 weeks				
	<input type="checkbox"/> Knee Support, Swing-Away, sz 1		1, 2	861154-2	\$829
	<input type="checkbox"/> Knee Support, Hinged, Swing-Away, sz 1		1, 2	861154-20	\$1,016
	<input type="checkbox"/> Knee Support, Swing-Away, sz 2		3, 4	861154-3	\$829
	<input type="checkbox"/> Knee Support, Hinged, Swing-Away, sz 2		3, 4	861154-30	\$1,016
	<input type="checkbox"/> Formed Footplates (Pr.)	L: 8½"	1, 2	86147	\$206
	<input type="checkbox"/> Formed Footplates (Pr.)	L: 9¼"	3, 4	86148	\$206
	<input type="checkbox"/> Foot Straps, Plastic Lock (Pr.)	Max: 22", A: 13½-20½"	One Size	85096	\$70
	<input type="checkbox"/> Foot Straps, Velcro (Pr.)		One Size	85102	\$64
	<input type="checkbox"/> Heel Support for Parted Foot Support (Pr.)		1, 2	861251	\$70
	<input type="checkbox"/> Heel Support for Parted Foot Support (Pr.)		3, 4	861252	\$70
	<input type="checkbox"/> Upholstered Ankle Straps (Pr.)		1	85426-1	\$231
	<input type="checkbox"/> Upholstered Ankle Straps (Pr.)		2	85426-2	\$231
	<input type="checkbox"/> Upholstered Ankle Straps (Pr.)		3	85426-3	\$231

Accessories	Description	Measurements	Size	Part No.	CAD Price
Both Trays can be used in Prone and Supine Position					
	<input type="checkbox"/> Tray, Plastic, with Bowl & Cover (Ea.)		1, 2	862130-2	\$698
	<input type="checkbox"/> Tray, Plastic, with Bowl & Cover (Ea.)		3, 4	862130-3	\$698
For Supine Use Only					
	<input type="checkbox"/> Low Mount Kit for Plastic Tray ♦		One Size	862131-KIT	\$256
	♦ Plastic Tray required (862130-2 or 862130-3)				
	<input type="checkbox"/> Armrest for Plastic Tray		One Size	861131	\$200
	<input type="checkbox"/> Toybar for Plastic Tray		One Size	861135	\$299
	<input type="checkbox"/> Grip Handle for Tray ♦♦		One Size	8910750	\$505
	♦♦ Custom order; Approx. lead time: 6-8 weeks				
	<input type="checkbox"/> Helper's Handle ♦		One Size	861108-U	\$175
♦ For moving and tilting the Caribou					

Spare Parts	Description	Measurements	Size	Part No.	CAD Price
	<input type="checkbox"/> Power Kit, Complete (Ea.)		1, 2	861140	\$2,893
	<input type="checkbox"/> Power Kit, Complete (Ea.)		3	861150	\$1,980
	<input type="checkbox"/> Power Kit, Complete (Ea.)		4	861160	\$1,980
	<input type="checkbox"/> Plug for USA/Canada (Ea.)		One Size	2222166	\$33
	<input type="checkbox"/> Batteries for Caribou with Power (Pr.) ♦		One Size	2222012	\$380
♦ Both batteries must be charged at the same time					

HCPCS codes are provided for your convenience and are NOT to be considered billing or legal advice. Providers are responsible for insuring that all appropriate billing codes are used when submitting claims. Proper use of HCPCS codes does not insure coverage or payment. Contact the appropriate payer for coverage information.

For shipping rates, please call 1-844-876-6245

12801 E Independence Blvd, Matthews, NC 28105 • 1-844-876-6245 • Web: www.r82.com

Prices in CAD & is subject to change without notice