

# R82 Crocodile - E8000

## CAD Retail Price List/ Order Form

Account #: \_\_\_\_\_ Purchase Order No.: \_\_\_\_\_ Date: \_\_\_\_\_  
 Contact: \_\_\_\_\_ Mark For: \_\_\_\_\_

Bill To:	Ship To:
Address:	Address:
City/State/Zip:	
Phone:	City/State/Zip:
Email	Phone:

**US Configuration**

**Effective: 12.28.20 - Rev 4**

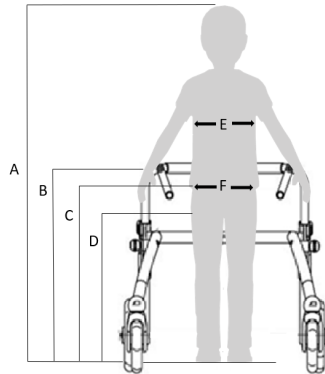

- A (Total Height) \_\_\_\_\_
- B (Floor to Wrist Height)\* \_\_\_\_\_
- \*with arms slightly bent at elbow*
- C (Top of Pelvis Height) \_\_\_\_\_
- D (Buttock Height) \_\_\_\_\_
- E (Chest Width) \_\_\_\_\_
- F (Pelvis Width) \_\_\_\_\_
- Age \_\_\_\_\_
- Weight \_\_\_\_\_

**Measurements**

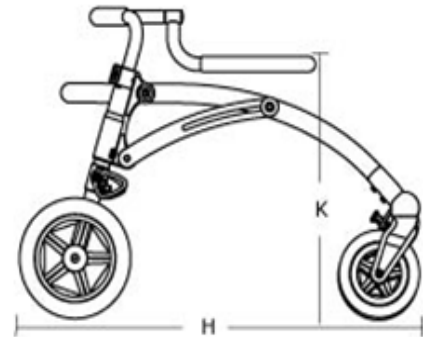
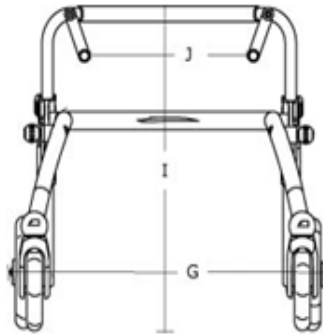

**Product Specs**

	Starter Kit My First Steps	Size 1	Size 2	Size 3
Width, Between handles (J)	3½-10"	7½-13½"	12½ - 23½"	13½-25¼"
Height, Floor to handles (K)	15 - 27 ½"	16½-28¼"	21¾-33"	29½-41¼"
Width, Max (G)	24½"	24½"	27¼"	27¼"
Length, Standard (H)	26"	28¼"	33"	34¼"
Height - Floor to Top Frame (I)	20½-30"	20½-30"	22¼-33"	32¾-43"
Length, Folded	28"	28"	33½"	39½"
Height, Folded	12"	12"	10½"	11"
Weight, Standard	12 lbs.	12 lbs.	14 lbs.	26½ lbs.
Turning Radius	39¼"	39¼"	45"	45"

**User Measurement Guide for Crocodile**

User Height, Maximum (A)	42¼"	42¼"	59"	70¾"
User Weight, Maximum	66 lbs.	66 lbs.	99 lbs.	176¼ lbs.

## Crocodile Standard Features

### Size 1 & 2

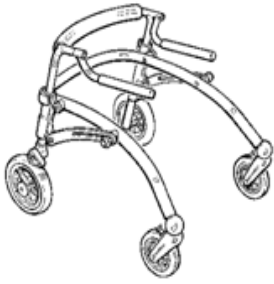



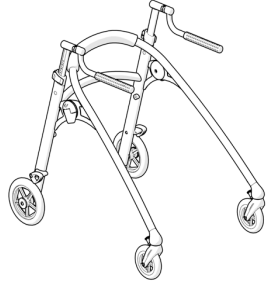



### Size 3













- Width & Height Adjustable Rotation Handles
- Easy to Fold
- Lightweight Durable Aluminum Frame (sz 1 and 2)
- Stable Steel & Aluminum Frame (sz 3)
- Upholstery & Cover for Top Frame
- Solid Front & Rear Wheels
- Swivel Front Casters with Castor Locks
- Adjustable Rear Drag Wheels
- On/Off Anti-Reverse Wheel Stop (Prevents Unit from Rolling Backwards)
- Padded Rear Stabilizer Bar with Tool Kit

Description	Size	Part No.	CAD Price
<input type="checkbox"/> Crocodile Gait Trainer, Standard Yellow	1	86801	\$923
<input type="checkbox"/> Crocodile Gait Trainer, Orange	2	86802	\$923
<input type="checkbox"/> Crocodile Gait Trainer, Black	2	86852	\$923
<input type="checkbox"/> Crocodile Gait Trainer, Metallic Grey ♦	3	86803	\$1,521
♦ Crocodile sz 3 requires Cross Bar for Back Support			

Accessories	Description	Measurements	Size	Part No.	CAD Price
	<input type="checkbox"/> Starter Kit Hand Brace Assy* *Allows lower handle height & narrower handle width	15" - 27 1/2"	1	86801-0	\$437
	<input type="checkbox"/> Forearm Support w/Handgrip (Pr.)	L:5 3/4 x W:3"	1	86858	\$461
	<input type="checkbox"/> Forearm Support w/Handgrip (Pr.)	L:7 x W:4"	2	86859	\$461
	<input type="checkbox"/> Forearm Support w/Handgrip (Pr.)	L:7 x W:4"	3	86860	\$461
	<input type="checkbox"/> Padded Forearm Positioner (Ea.)		One Size	869370	\$85
	<input type="checkbox"/> Pelvic Pad w/Lateral (Ea.) ♦	3 1/2" x 4 3/4" - 9"	Small	86808	\$327
	<input type="checkbox"/> Pelvic Pad w/Lateral (Ea.) ♦	3 1/2" x 7" - 11 1/2"	Large	86809	\$327
♦ Required when using Sling Seat Lightweight					
	<input type="checkbox"/> Lateral Strap for Pelvic Pad (Ea.) ♦		One Size	905011	\$64
♦ Required with Sling Seat Lightweight					
	<input type="checkbox"/> Back Support, Angle and Width Adj. ♦	9 1/2" - 11 1/2" x 7"	3	86886	\$630
♦ Crossbar Required (86880)					
	<input type="checkbox"/> Back Support Strap, Small (Ea.) ♦	11 1/2" x 3"	3	85490-1	\$109
	<input type="checkbox"/> Back Support Strap, Large (Ea.) ♦	13 1/2" x 4"	3	85490-2	\$109
♦ For Back Support (86886)					
	<input type="checkbox"/> Cross Bar for Back Support (Ea.) ♦		3	86880	\$121
♦ Required with Back Support (86886)					
	<input type="checkbox"/> Sling Seat, Lightweight (Ea.) ♦	23 1/2" (Waist)	1	86824-1	\$168
	<input type="checkbox"/> Sling Seat, Lightweight (Ea.) ♦	27 1/4" (Waist)	2	86825-1	\$168
♦ Requires Pelvic Pad w/ Laterals Small or Large and Lateral Strap					
	<input type="checkbox"/> Sling Seat (Ea.)	23 1/2" (Waist)	1	86824	\$168
	<input type="checkbox"/> Sling Seat (Ea.)	27 1/4" (Waist)	2	86825	\$168

Accessories	Description	Measurements	Size	Part No.	CAD Price
	<input type="checkbox"/> Solid Seat, Yellow (Ea.)*	11½" (Seat to Floor Height)	1	86820	\$212
	<input type="checkbox"/> Solid Seat, Orange (Ea.)*	16¾" (Seat to Floor Height)	2	86821	\$212
	<input type="checkbox"/> Solid Seat, Black (Ea.)*	16¾" (Seat to Floor Height)	2	86823	\$212
	<input type="checkbox"/> Solid Seat, Metallic Grey (Ea.)*	22" (Seat to Floor Height)	3	86863	\$212
	<b>*Can Not be used with Starter Kit</b>				
	<input type="checkbox"/> Handle Knobs (Pr.)		All Sizes	86861	\$64
	<input type="checkbox"/> Anti-Tip Device, Swing-Away (Pr.)		1, 2	86815	\$200
	<input type="checkbox"/> Anti-Tip Device, Swing-Away (Pr.)		3	86815-3S	\$200
	<input type="checkbox"/> Anti-Tip Device, Fixed (Pr.)		1, 2	86815-F	\$96
	<input type="checkbox"/> Anti-Tip Device, Fixed (Pr.)		3	86815-3F	\$102
	<input type="checkbox"/> Hand Brake**		1, 2	86834	\$299
	<input type="checkbox"/> Hand Brake**		3	86873	\$299
	<b>* Hand brake eliminates the function of anti-reverse wheel stop</b>				
	<b>* If ordering hand brake with anti-reverse wheel stop function, a custom order required</b>				
	<input type="checkbox"/> Custom, Hand Brake with Anti-reverse Wheel Stop**			8697	Custom
	<b>** Custom order; Approx. lead time: 6-8 weeks. Non-returnable item</b>				
	<b>^ If mounting vertically on forearm support, a custom order required</b>				
	<input type="checkbox"/> Custom, Hand Brake on Vertical Mount Kit**			9774	Custom
	<b>** Custom order; Approx. lead time: 6-8 weeks. Non-returnable item</b>				
	<input type="checkbox"/> Attendant Guide Bar (Ea.)		1, 2	86866	\$150
	<input type="checkbox"/> Storage Bag (Ea.) ♦	7" x 11"	1, 2	86839	\$89
	<input type="checkbox"/> Storage Bag (Ea.) ♦	11" x 14"	3	86843	\$262
	<b>♦ Sz 1 &amp; 2 has 6 ½ lbs. weight limit, sz 3 has a 11 lbs. weight limit</b>				

Spare Parts	Description	Measurements	Size	Part No.	CAD Price	QTY
	<input type="checkbox"/> Cover for Top Frame		1	86813	\$109	
	<input type="checkbox"/> Cover for Top Frame		2	86814	\$109	
	<input type="checkbox"/> Cover for Top Frame		3	86883	\$109	
	<input type="checkbox"/> Handle (Ea.)		1, 2	86833-TD	\$144	_____
	<input type="checkbox"/> Handle (Ea.)		3	86862	\$137	_____
	<input type="checkbox"/> Cover for Handle, Version 1-4		1, 2	2500520	\$28	_____
	<input type="checkbox"/> Cover for Handle, Version 5		1, 2	2500530	\$41	_____
	<input type="checkbox"/> Cover for Handle		3	2500520	\$28	_____
	<input type="checkbox"/> Standard Upper Handbrace Assy. 16 ½" - 28"		1	100783-1	\$536	
	<input type="checkbox"/> Standard Upper Handbrace Assy. 21 ½" - 33"		2	100783-2	\$536	
	<input type="checkbox"/> Knob for Folding Mechanism (Ea.)		1, 2	3470393	\$26	_____

Spare Parts	Description	Measurements	Size	Part No.	CAD Price
	<input type="checkbox"/> Lock Parts for Handle Bar (Pr.)		1, 2	86831	\$20
	<input type="checkbox"/> Lock Part for Handle and Cross Bar (Pr.)		3	86831-3U	\$26
	<input type="checkbox"/> On/Off Anti-Reverse Wheel Stop (Pr.)		1, 2	86828	\$60
	<input type="checkbox"/> On/Off Anti-Reverse Wheel Stop (Pr.)		3	86828-3U	\$57
	<input type="checkbox"/> Front Fork, Right		1, 2	86837-H	\$193
	<input type="checkbox"/> Front Fork, Left		1, 2	86837-V	\$193
	<input type="checkbox"/> Front Fork, Right		3	86837-3H	\$193
	<input type="checkbox"/> Front Fork, Left		3	86837-3V	\$193
	<input type="checkbox"/> Front Wheel, Universal (Ea.)		One Size	86838	\$74
	<input type="checkbox"/> Rear Wheel, Right, Complete		1, 2	86835-1HM	\$299
	<input type="checkbox"/> Rear Wheel, Left, Complete		1, 2	86835-1VM	\$299
	<input type="checkbox"/> Rear Wheel, Right, Complete		3	86835-2HM	\$299
	<input type="checkbox"/> Rear Wheel, Left, Complete		3	86835-2VM	\$299
	<input type="checkbox"/> Rear Wheel		One Size	8000102	\$94

HCPCS codes are provided for your convenience and are NOT to be considered billing or legal advice. Providers are responsible for insuring that all appropriate billing codes are used when submitting claims. Proper use of HCPCS codes does not insure coverage or payment. Contact the appropriate payer for coverage information.

Prices in CAD & is subject to change without notice

**For Quotes and Orders please send completed Order Form to: [sales.us@etac.com](mailto:sales.us@etac.com) or fax: 1-800-760-0537**

Etac  
13137 Bleinheim Lane  
Matthews, North Carolina 28105  
+1 844-US-MOBILITY (844-876-6245)  
[www.etac.us.com](http://www.etac.us.com)

  
Creating Possibilities