

R82 Heron

CAD Retail Price List/ Order Form

Account #: _____ Purchase Order No.: _____ Date: _____
 Contact: _____ Mark For: _____

Bill To:	Ship To:
Address:	Address:
City/State/Zip:	
Phone:	City/State/Zip:
Email	Phone:

US Configuration

Effective: 05.01.21 - Rev 3

- Heron
- Head support
- Back support
- Swing away side support
- Arm rest/tray
- Foot and hip supports
- Commode pan
- Splash guard
- Vests and belts



- A (Back height) _____
- B (Arm height) _____
- C (Lower leg length) _____
- D (Seat depth) _____
- E (Chest width) _____
- F (Seat width) _____
- G (Height from seat to top of head) _____
- H (Shoulder width) _____
- Age _____
- Weight _____

Measurements

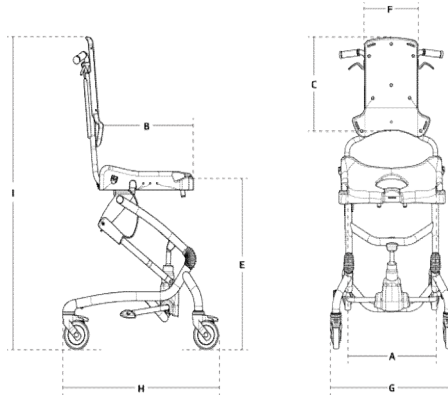

Heron

Seat width (A)	21¾"
Seat width with hip supports (accessories)	13¾"-19¼"
Seat depth (B)	17¾"
Seat depth with reduction kit (accessories)	15¾"
Back height (C)	21¾"-24½"
Lower leg length (D)	15¾"-22"
Seat height above floor (E)	20-30¾"
Back width (F)	11½"
Width, frame (G)	26½"
Length, frame (H)	28"
Height, frame w/seat (I)	42½"-53¼"
Seat angling (tilt in space)	-5° to +25°
Back angling	90° to +120°
Weight, without arm rests	61.5 lbs.
Max. Load/user weight	220.4 lbs.

Heron Standard Features



- One size
- 4 grey castors with locks
- Stainless steel frame
- Height adjustable frame
- Integrated push handles
- Built-in tilt in space
- Built-in recline
- Active, height adjustable back
- Potty ring

Description	Size	Part No.	CAD Price
<input type="checkbox"/> Heron	One Size	880505-01	\$6,710

Accessories	Description	Measurements	Size	Part No.	CAD Price
-------------	-------------	--------------	------	----------	-----------

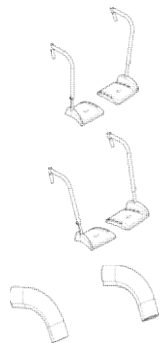

<input type="checkbox"/> Foot Support, Right-Angled Knee (Pr.) <i>(lower leg range: 15 1/2"-22")</i>	One Size	880506-01	\$633
<input type="checkbox"/> Foot Support, Open Knee Angle (Pr.) <i>(lower leg range: 15 1/2"-22")</i>	One Size	880506-02	\$633
<input type="checkbox"/> Padding for Foot Supports (Pr.)	One Size	880506-12	\$83

Description	Size	Part No.	CAD Price
-------------	------	----------	-----------

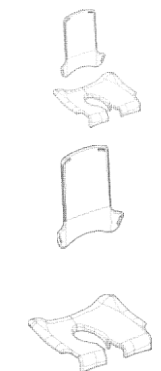

<input type="checkbox"/> Upholstery, Complete (Set)	One Size	880507-01	\$377
<input type="checkbox"/> Upholstery, Back Only (Ea.)	One Size	101204	\$185
<input type="checkbox"/> Upholstery, Seat Only (Ea.)	One Size	117005	\$207

Description	Size	Part No.	CAD Price
-------------	------	----------	-----------



<input type="checkbox"/> Armrest, Swing-Away (Pr.)	2 x 14 1/2 x 9 3/4"	One Size	880508-03	\$620
--	---------------------	----------	-----------	-------

Description	Size	Part No.	CAD Price
-------------	------	----------	-----------

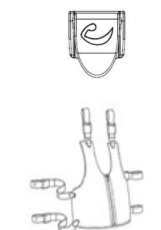

<input type="checkbox"/> Fix-Locks, White, Bag of 4 Pcs ** **Required for use of Vests	One Size	890505-36	\$51
<input type="checkbox"/> Vest	3	89111-340	\$256
<input type="checkbox"/> Vest	4	89111-440	\$256
<input type="checkbox"/> Neoprene Hip-Belt	2	85423-2	\$124

Accessories	Description	Measurements	Size	Part No.	CAD Price
-------------	-------------	--------------	------	----------	-----------



Sides/Wings (Pr.) 4 x 14" One Size 880508-01 \$109

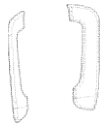

Upholstery for Sides/Wings (Pr.) 4 x 14" One Size 880507-04 \$109

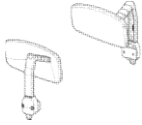

Hip Supports (Pr.) 8¼"W x 4"H One Size 880508-02 \$403
(seat width range: 13 ½"-22")

Description	Measurements	Size	Part No.	CAD Price
-------------	--------------	------	----------	-----------

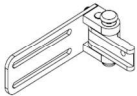

Swing-Away Bracket, Stainless, Right (Ea.) One Size 83000-R \$288

Swing-Away Bracket, Stainless, Left (Ea.) One Size 83000-L \$288



Bar, Straight, Stainless (Ea.) 6¼" One Size 82648 \$0

Bar, Offset, 1" Stainless, (Ea.) 4¾" One Size 150238 \$0

Cushion, Curved (Ea.) 3½ x 7½" One Size 6175407 \$134

Cushion, Curved (Ea.) 2½ x 6½" One Size 6175408 \$134

Cushion, Curved (Ea.) 2½ x 5¾" One Size 6175409 \$134

Protection Pads (Ea.) One Size 89151 \$118

Description	Measurements	Size	Part No.	CAD Price
-------------	--------------	------	----------	-----------

Headrest 2, Grey One Size 6172000 \$262

Headrest 3, Grey One Size 6173000 \$262

Headrest 4, Grey One Size 6174000 \$262

Swing-away Mounting Brackets - Height, Depth, Angle and Lateral Adjustable

Stainless Turtle Bar System One Size 98619-24 \$294

Stainless Bar System, Straight ●● 9" One Size 87583 \$294

Stainless Bar System, Straight ●● 14½" One Size 87585 \$294

Stainless Swan Neck ●● 7½ x 4" One Size 87580 \$256

Stainless Swan Neck ●● 13½ x 7¾" One Size 87582 \$313

●●Custom order; Approx. lead time: 6-8 weeks.

Description	Measurements	Size	Part No.	CAD Price
-------------	--------------	------	----------	-----------



Tray; Mounted in Armrest 17¼ x 7½" One Size 880508-04 \$403

Description	Measurements	Size	Part No.	CAD Price
-------------	--------------	------	----------	-----------



Commode Pan 7¾ x 13½ x 4¾" One Size 880130 \$65

Lid for Commode Pan One Size 880130-L \$83







Splash Guard 3 x 5¼" One Size 880508-05 \$89



Splash Guard, Low ●● One Size 880508-07 \$82

●●Custom order; Approx. lead time: 6-8 weeks.

Accessories	Description	Measurements	Size	Part No.	CAD Price
	<input type="checkbox"/> Calf Support, Strap (Ea.)	4"	One Size	880509-01	\$83
	<input type="checkbox"/> Heel Stops, Straps (Pr.)	1½"	One Size	880509-02	\$153
	<input type="checkbox"/> Shock Absorber, White ●● ●● <i>Custom order; Approx. lead time: 6-8 weeks.</i>		One Size	116924-KIT	\$48

Spare Parts	Description	Measurements	Size	Part No.	CAD Price
	<input type="checkbox"/> Potty Ring		One Size	109072	\$55

HCPCS codes are provided for your convenience and are NOT to be considered billing or legal advice. Providers are responsible for insuring that all appropriate billing codes are used when submitting claims. Proper use of HCPCS codes does not insure coverage or payment. Contact the appropriate payer for coverage information.

Prices in CAD & is subject to change without notice
For Quotes and Orders please send completed Order Form to: us.info@r82.com

Etac
13137 Bleinheim Lane
Matthews, North Carolina 28105
+1 844-US-MOBILITY (844-876-6245)
www.etac.us.com

OF5502-ENG-REV.03

 **etac**[®]
Creating Possibilities